

SIDIGITAL
Product Catalogue

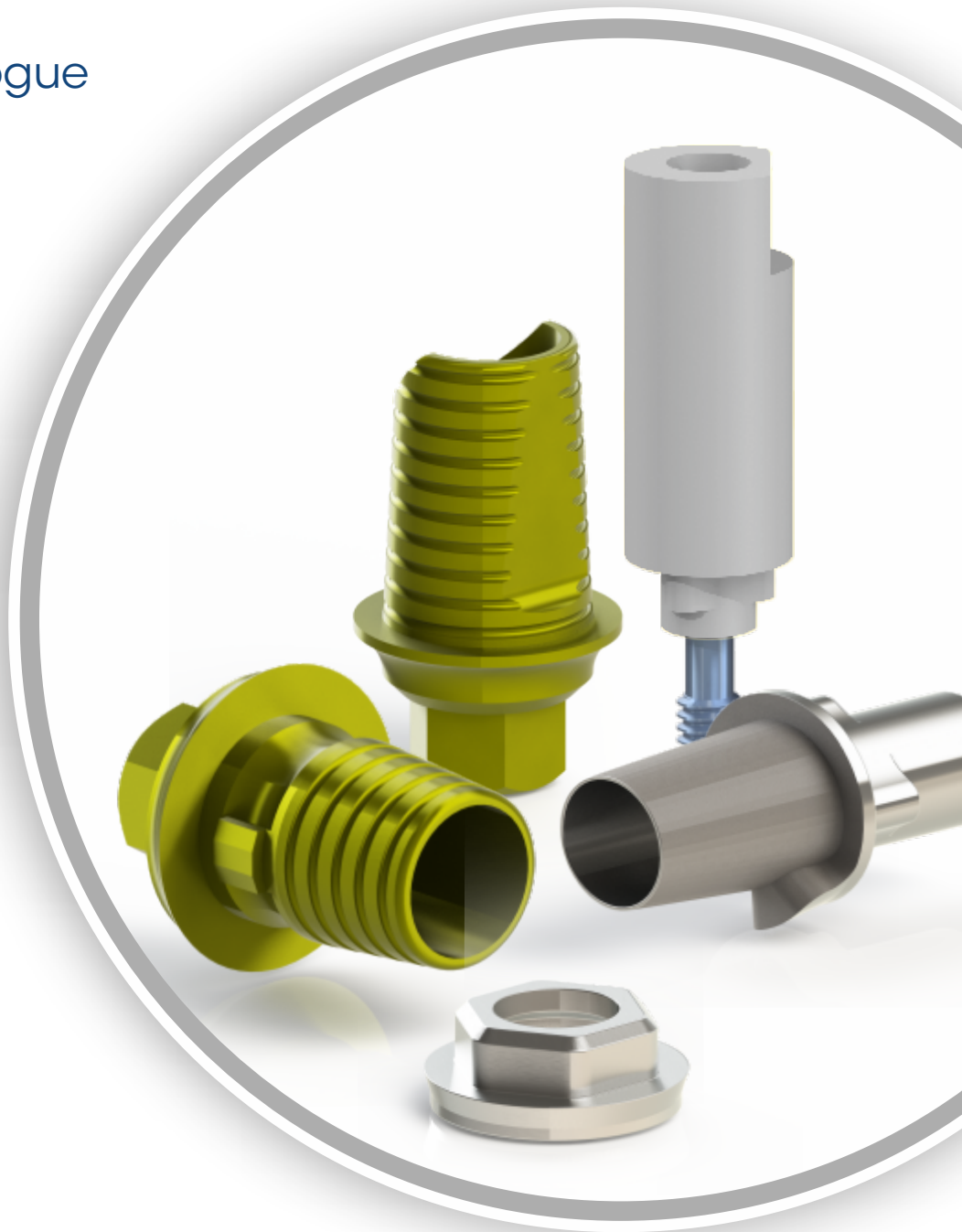

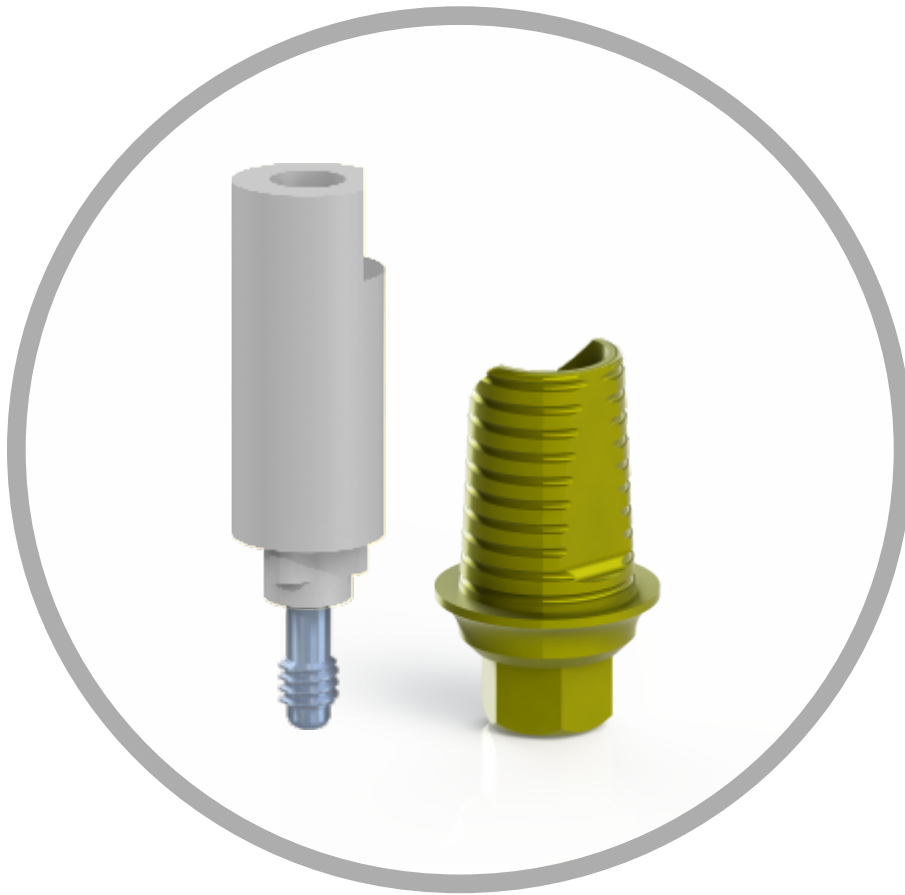

SiDigital is Southern Implants' comprehensive digital solution for CAD/CAM procedures.

Precision is one of the most important aspects of any dental restoration, and this becomes more significant when it comes to digital dentistry. Southern's digital solutions provide digital tools which accurately facilitate the digital workflow between dentist and laboratory for CAD/CAM procedures. This is achieved through the use of digital libraries and our unique abutment options, to cater for single unit and multiple unit restorations, all in the digital workflow.

Dental professionals wanting to work with SiDigital workflow procedures, will need to download and install the SiDigital libraries into either 3Shape, Exocad or Dental Wings software systems. These digital libraries link the intra-oral/desktop scan, model creator, design software and milling of the restoration.

My sincere thanks to all specialists, dentists and technicians who give continual feedback, suggestions and input. Our products are an interpretation of your needs.

Graham Blackbeard
Managing Director, Southern Implants

CONTENTS

Introduction	Page 05
SIDigital Libraries and Abutment Selection	Page 10
scan flags.....	Page 16
Lab Analogues.....	Page 20
ABUTMENT SELECTION	
CIA Abutments.....	Page 26
CAB Abutments.....	Page 28
TIB Abutments.....	Page 30
Procedures for Use	
CIA, CAB and TIB Abutments using SIDigital libraries.....	Page 35
TIB Abutments used with Sirona.....	Page 37
Passive Abutments.....	Page 38
Procedure for Use	
Passive Abutment.....	Page 41
Final Milling	Page 46
Southern Implants CAD/CAM workflow for Exocad, 3Shape, Dental Wings & Sirona	
External Hex.....	Page 50
M-Series (Internal Hex).....	Page 62
PROVATA™.....	Page 66
DC (Deep Conical).....	Page 72
TRI-NEX.....	Page 80
IT (Internal Octagon) Range.....	Page 90
Driver & Screw Information.....	Page 94
Instrument Information.....	Page 95
Polishing Protector Caps.....	Page 96
Instructions for Use.....	Page 97
Explanation of Symbols.....	Page 99

Please note:

- Images are for illustration purposes only and do not necessarily accurately represent the product.
- All dimensions in this catalogue are in mm, unless otherwise specified.
- Not all products are cleared for sale in all countries.

SIDIGITAL is Southern Implants' digital offering for use in CAD/CAM procedures.

Precision is the most important aspect in any dental restoration and this is more relevant with SIDigital. Southern's digital solutions provide digital tools which accurately facilitate the digital workflow between dentist and laboratory during CAD/CAM procedures. This is achieved with the use of digital libraries and Southern Implants' unique abutment options, which allows for single and multiple unit restorations all in a digital workflow.

Dental professionals working with digital workflow procedures are required to download and install SIDigital libraries into 3Shape, Exocad, and/or Dental Wings software systems. Digital libraries are the link between the intraoral / desktop scan, model creator, design software, and restoration milling.

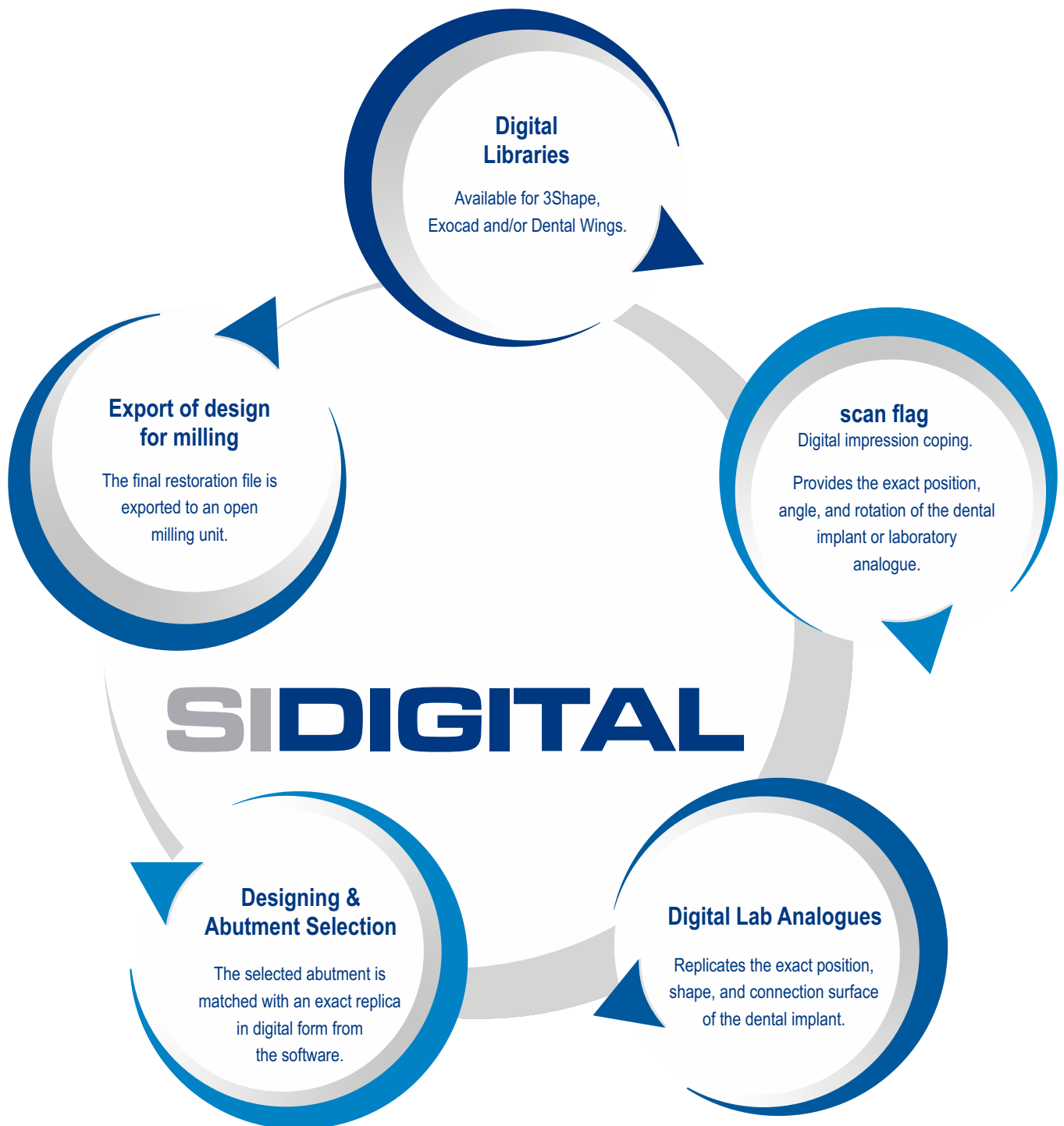

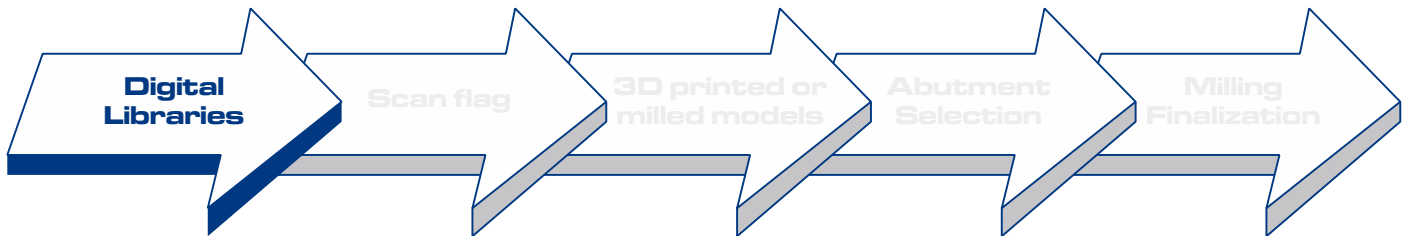

SIDigital libraries are available for all dental professionals and are free to download. A digital workflow with digital libraries makes it easier to get consistent and accurate results when designing restorations. This is due to the digital file being the link to the different steps in the workflow, and the components in the library are exact replicas of the physical parts. By using the libraries, you are enabled to create complete dental restorations with an optimal fit.

- The libraries are available for 3Shape, Exocad, and/or Dental Wings.
- SIDigital libraries need to be imported into these systems.

Procedure to register online:

- Go to www.southernimplants.com
- Click on SIDigital solutions
- Scroll down and click “CAD/CAM library Access & Login”

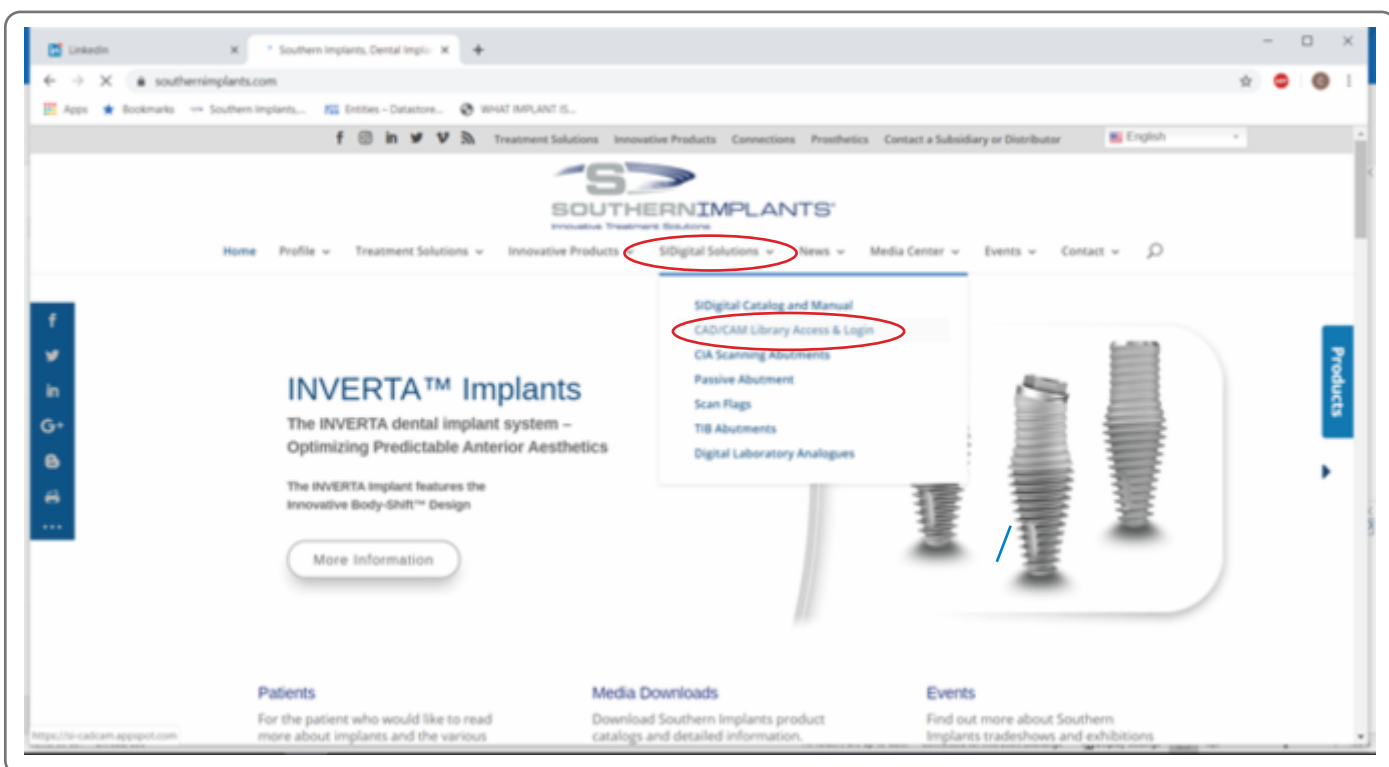

- Complete the registration form while taking care to provide the correct email address to receive updates.
- Accept terms and conditions, and submit.

NB! Only register ONCE!

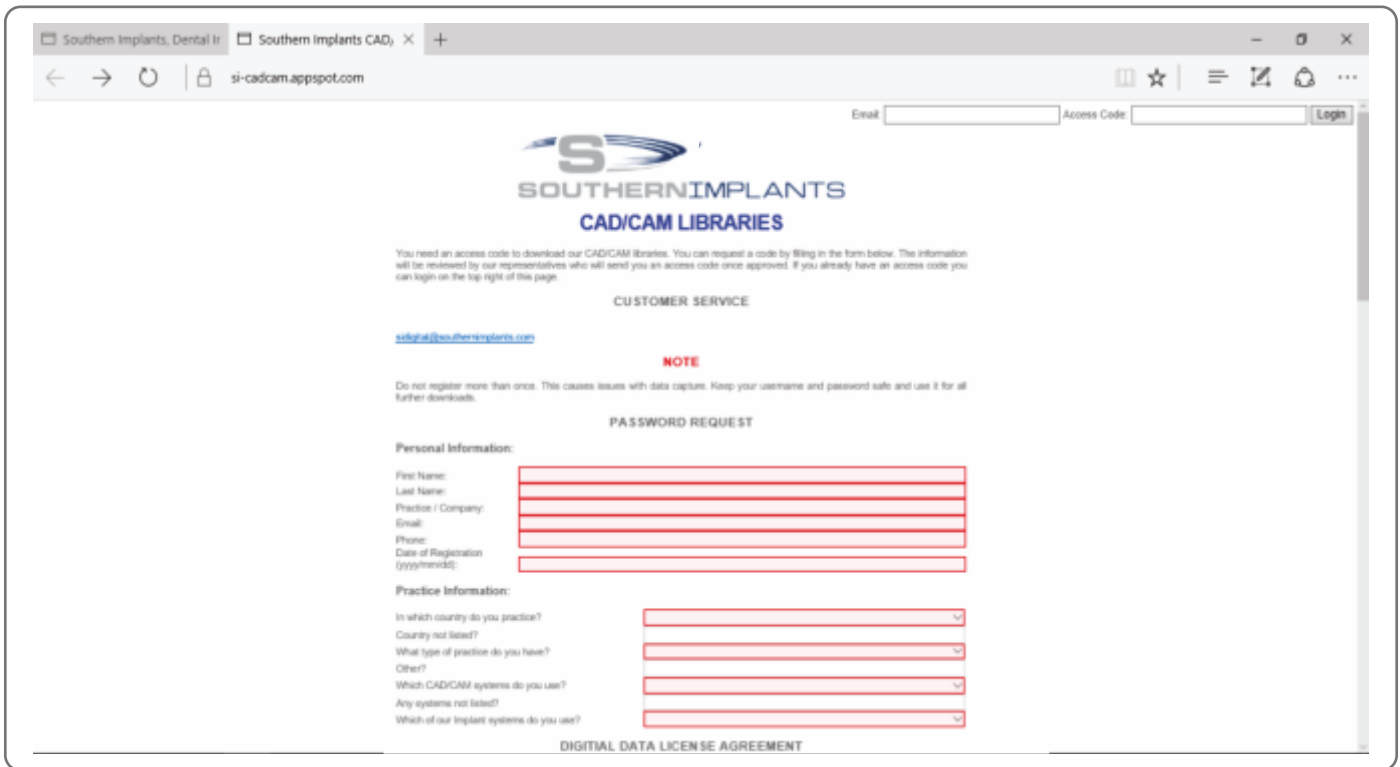

- The dental professional will then be provided with their unique “password” or “access code” as login details (via e-mail).

Procedure to download libraries:

- To download the libraries visit www.southernimplants.com and follow the same steps as above to get to the registration page.
- At the top right corner enter your email address and access code obtained from SIDigital and login.

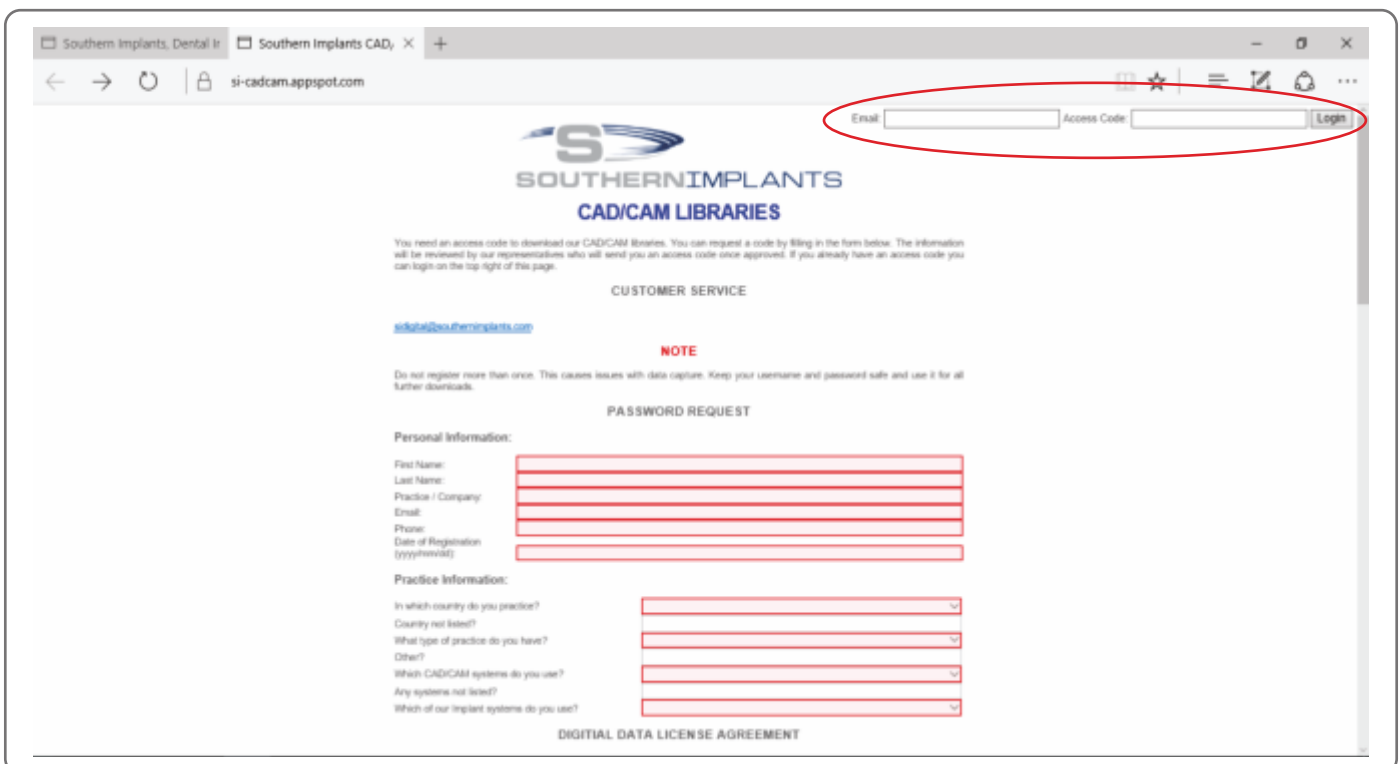

Library installation instructions:

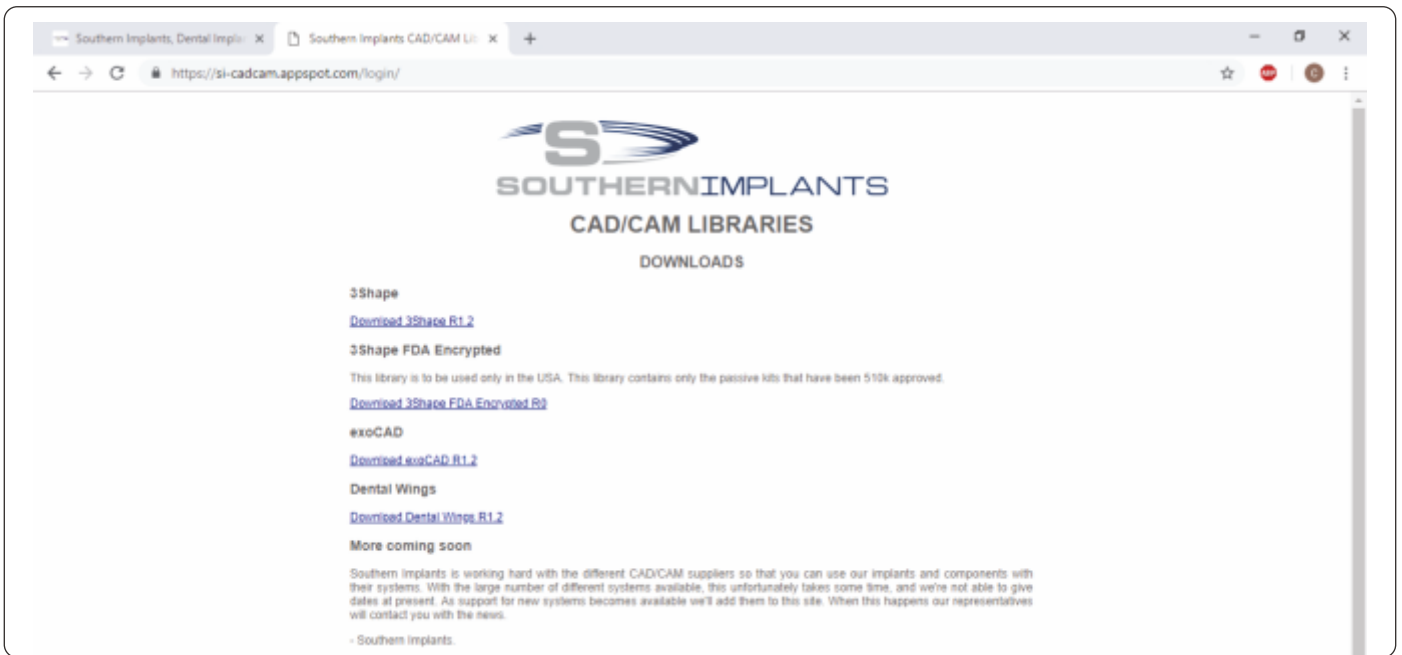

Select either 3Shape, Exocad or Dental Wings.

NOTE: USA users must download the 3Shape FDA encrypted library

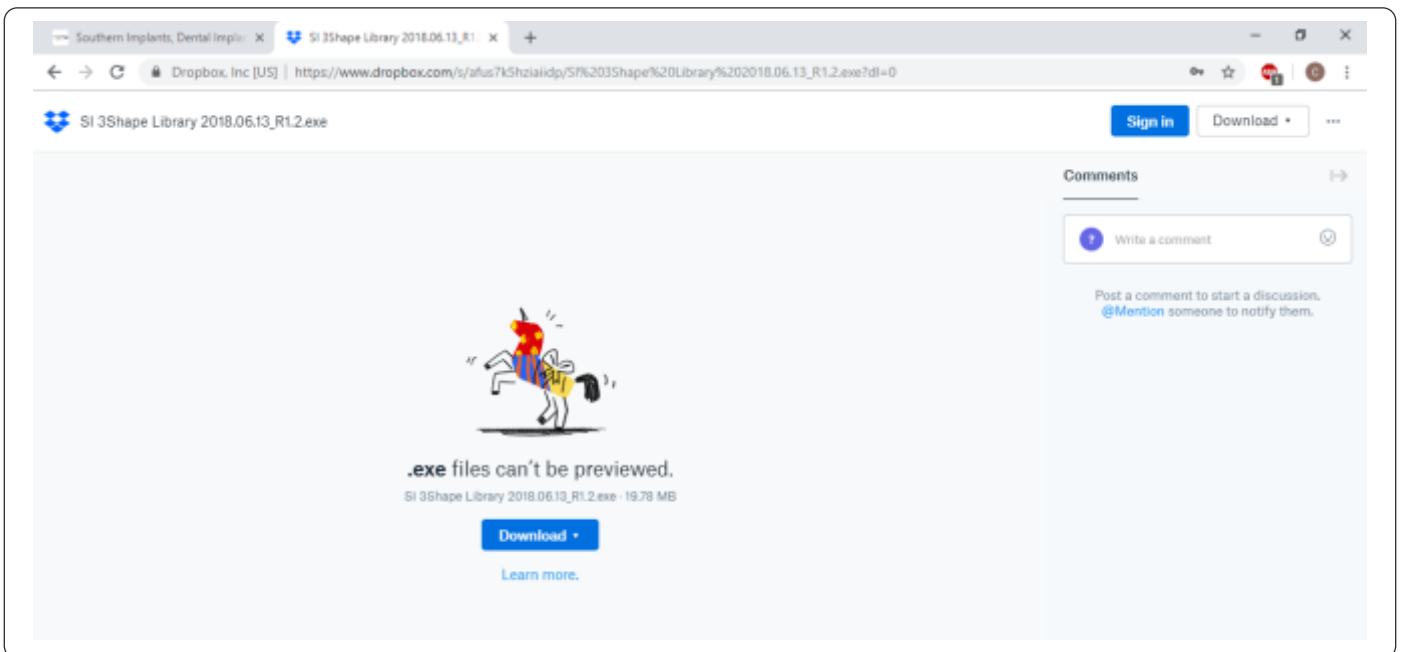

SIDigital libraries are packaged as ".exe extension" type since 3Shape, Exocad, and Dental Wings all have different file types.

- Open Southern Implants and click on the library to download. (If a screen comes up prompting if the library should be run click "Run anyway".)

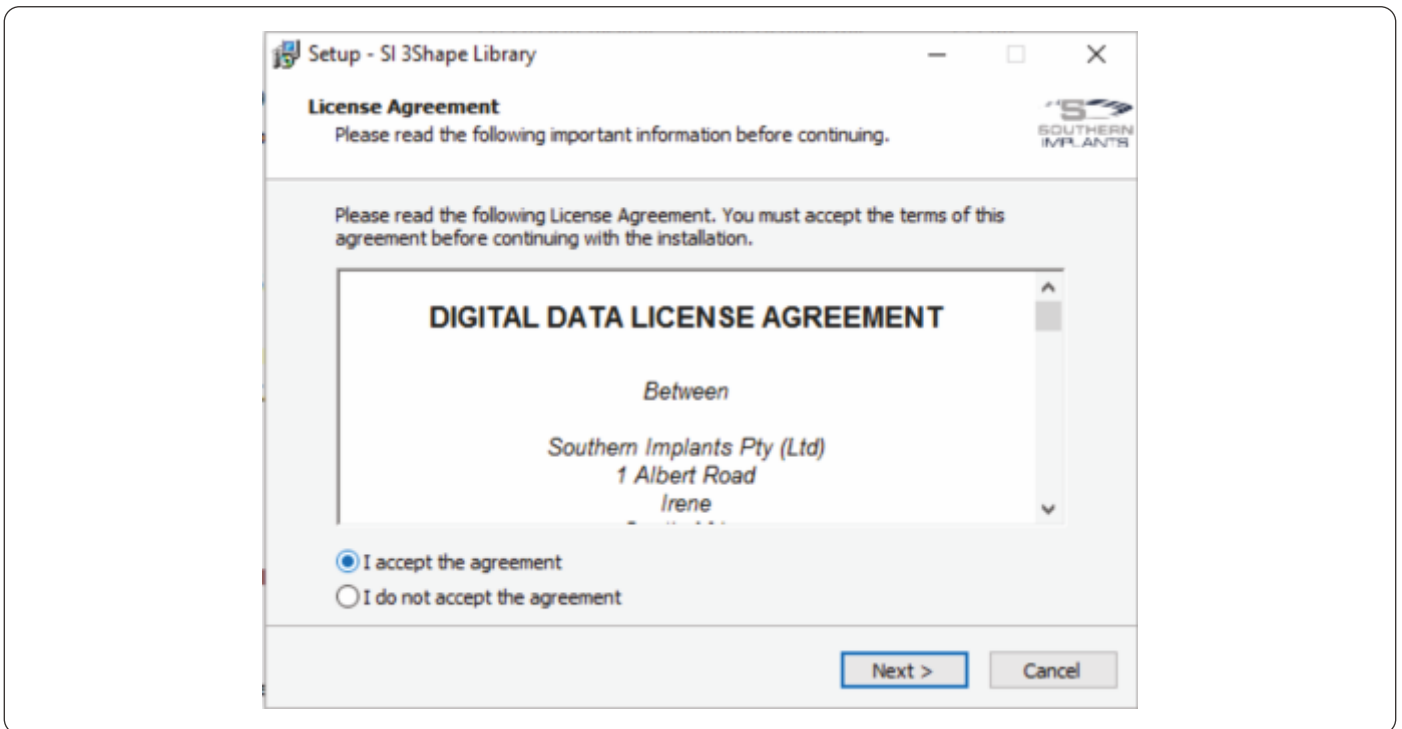

- Accept the agreement, and click next.

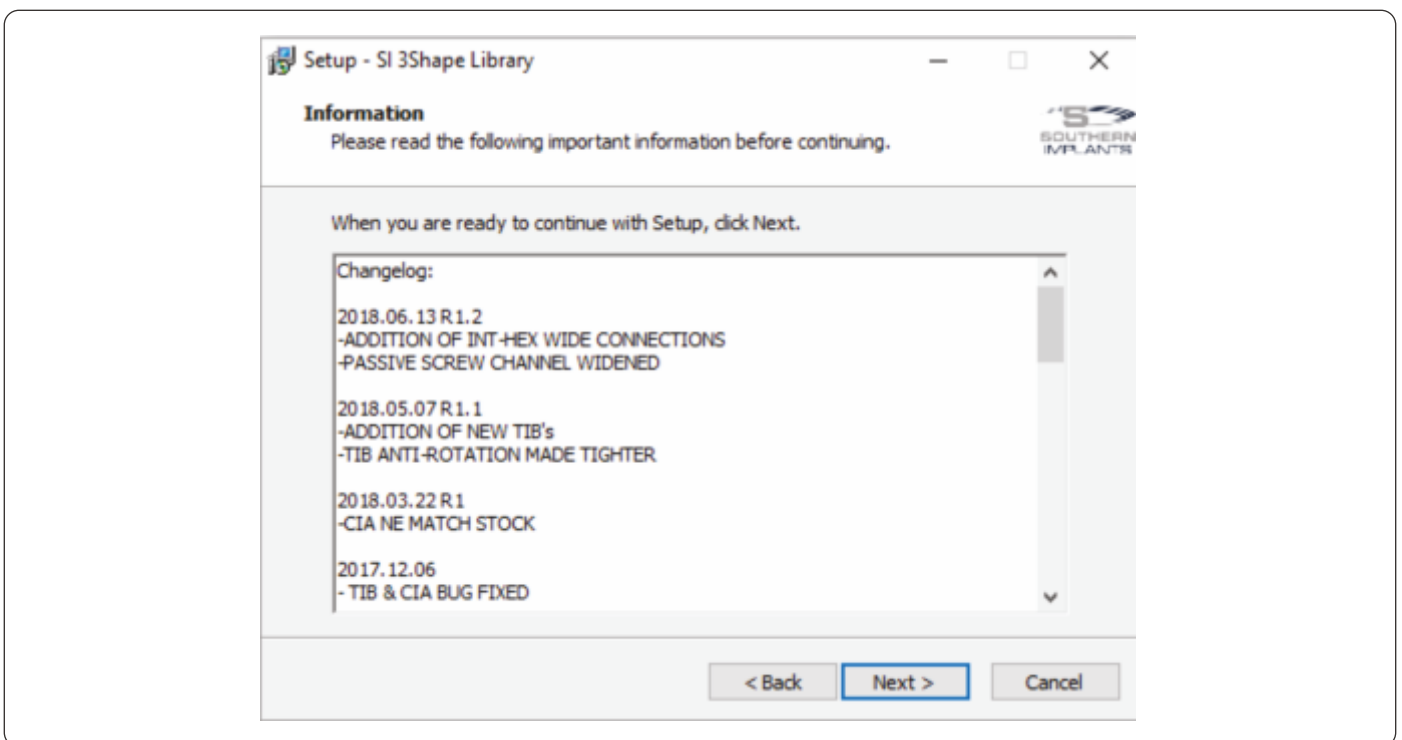

- A log of changes and updates made to the libraries appears, continue by clicking next.

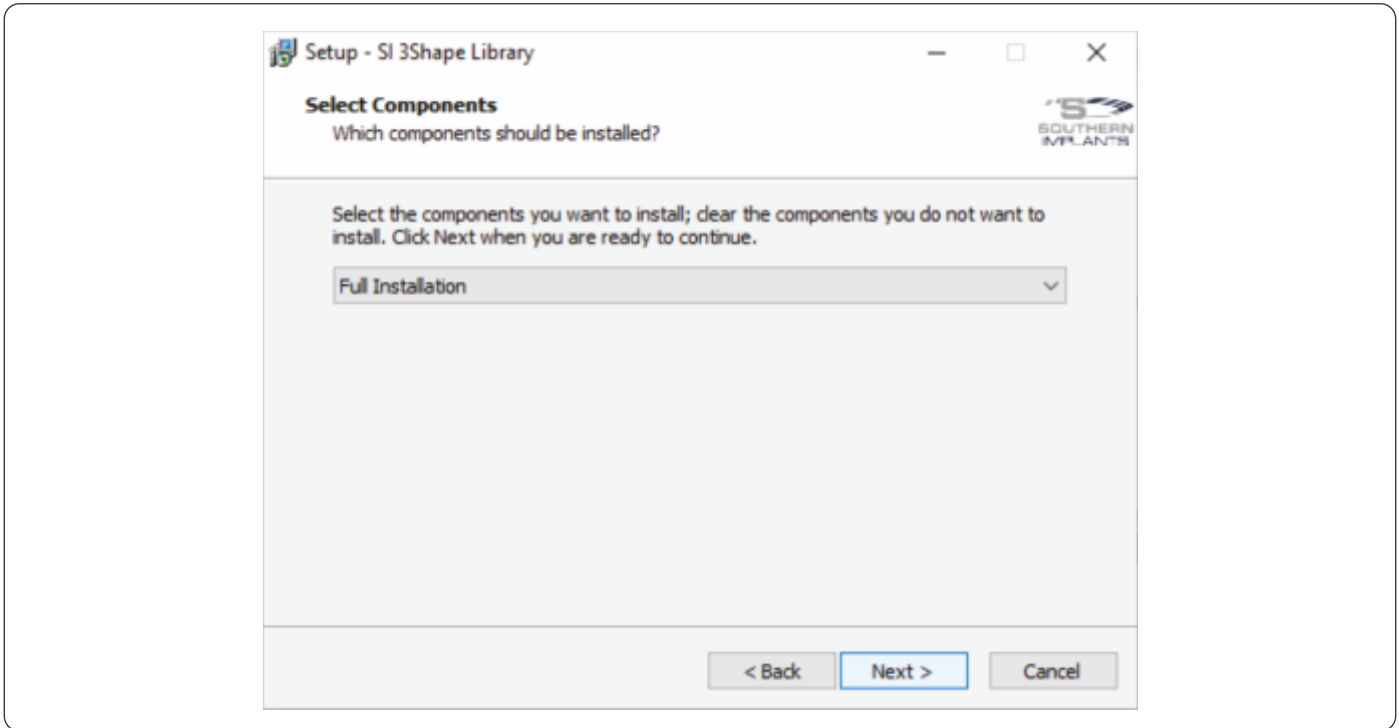

The next window will ask for full installation, continue by clicking next.

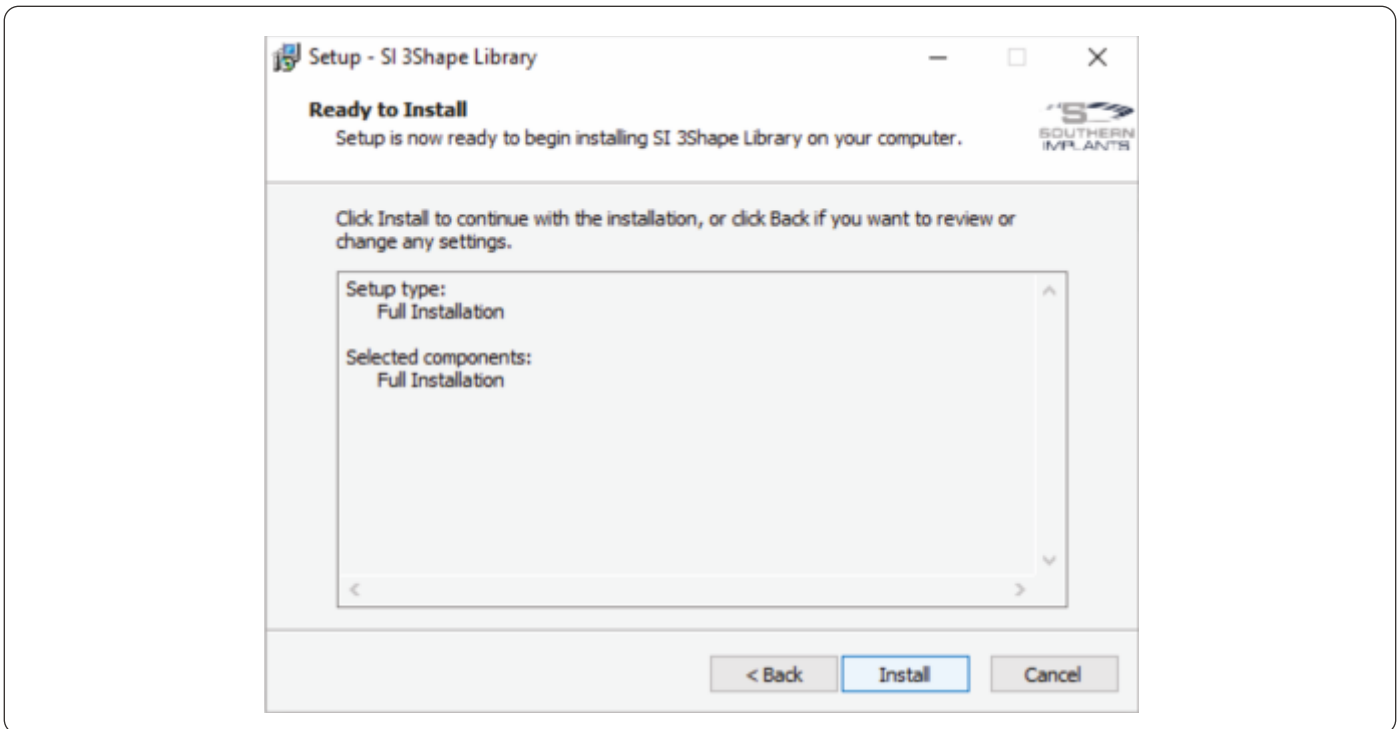

Install the library.

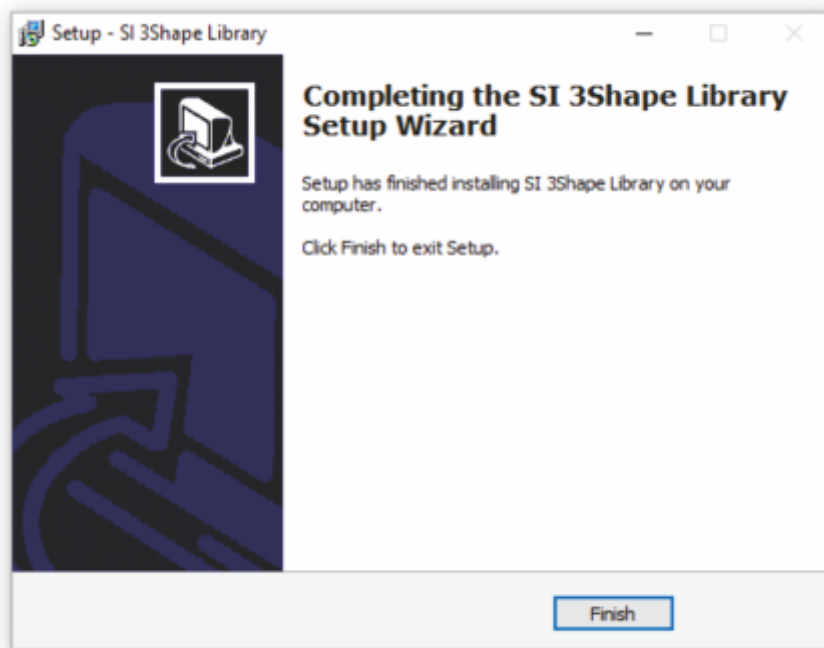

Click on Finish

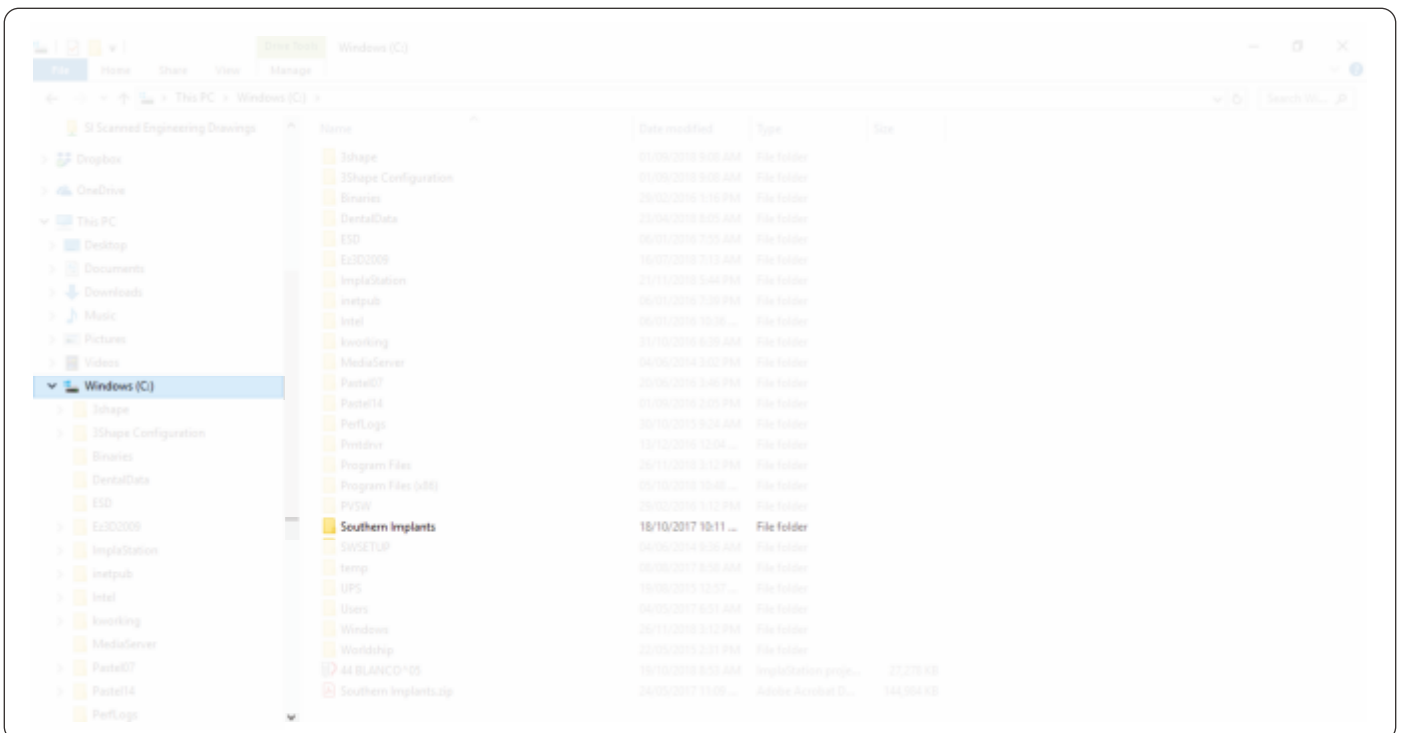

- The library will download on the local disk "C:" drive, in a folder labelled "Southern Implants".
- When installing the library into the software of choice, download the library from this "Southern Implants" folder on the local disk "C:" drive.

Note:

- **Do not register more than once on the website.** If you have, please email sidigital@southernimplants.com for assistance.
- You can re-download the library as many times as you want with your access code. This code does not expire and can be used numerous times.

DIGITALLY OBTAINING THE IMPLANT/ANALOGUE POSITION

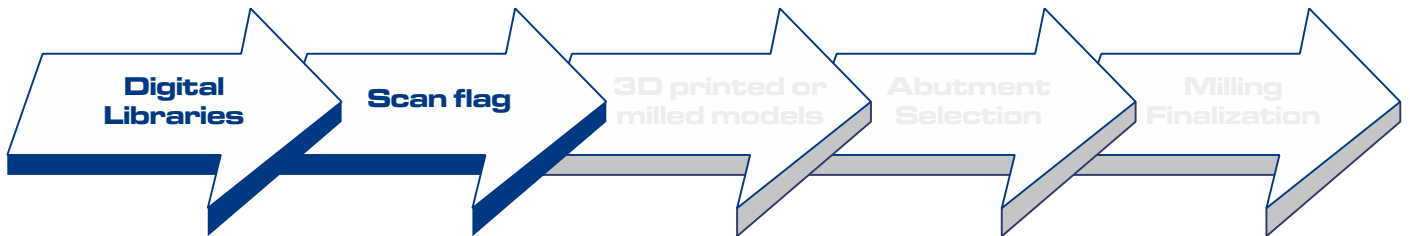

SCAN FLAGS







Intended use:

Southern Implants' scan flags are intended to be used during the digital impression procedure, in order to obtain the exact position and orientation of the respective dental implant or laboratory analogue, and transfer this position digitally during CAD/CAM scanning procedures. This aids the CAD/CAM software to align the CAD/CAM components to the implant in a digital format.

Description:

The scan flags are pre-manufactured and are available in different connection types. The Scan flags are made from Titanium and is supplied with a screw to secure the scan flag onto the dental implant or analogue.





EXTERNAL HEX

Order Number	to be used with	Driver
 SFT-EX-30	Ø3mm External Hex implant (Piccolo)	 I-HD-22U-M (1.22/1.27 Universal)
 SFT-EX-34	Ø3.25mm External Hex implant (IBN / IBNT)	
 SFT-EX-40	Ø4mm External Hex implant (IB / IBT) & MAX-6	
 SFT-EX-50	Ø5mm External Hex implant & MAX-7	
 SFT-EX-60	Ø6mm External Hex implant & MAX-8	



TRI-NEX

Order Number	to be used with	Driver
 SFT-EL-35	Ø3.5mm TRI-NEX implant	 I-UGI-M (Unigrip)
 SFT-EL-43	Ø4.3mm TRI-NEX implant	
 SFT-EL-50	Ø5mm TRI-NEX implant & TRI-MAX-7	
 SFT-EL-60	Ø6mm TRI-NEX implant & TRI-MAX-8 & 9	



DC RANGE

Order Number	to be used with	Driver
 SFT-DC3	Ø3mm Deep Conical implant	 I-HD-M (1.22 hex)
 SFT-DC4	Ø3.5mm & Ø4mm Deep Conical implant	
 SFT-DC5	Ø5mm Deep Conical implant	

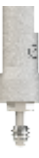

INTERNAL HEX RANGE (M-SERIES & PROVATA®)

Order Number	to be used with	Driver
 SFT-M	Ø3.7mm / Ø4.2mm / Ø5mm Internal Hex implants (M-series)	 I-SCCL-M
	Ø4mm / Ø5mm Provata	
	Ø6mm PROMAX implants	
 SFT-Z	Ø7mm / Ø8mm / Ø9mm PROMAX implants	I-HD-27-M (1.27 hex)

IT (INTERNAL OCTAGON) RANGE

Order Number	to be used with	Driver
 SFT-IT	Ø4.8mm IT implants & MAXIT7	 I-SCS-M (Torx)
 SFT-IT6	Ø6.5mm IT implants & MAXIT8 & 9	

ABUTMENT LEVEL (COMPACT CONICAL ABUTMENT)

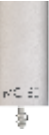
Order Number	to be used with	Driver
 SFT-MC-48	Ø4.8mm platform Compact conical abutments	 I-HD-M (1.22 hex)
 SFT-MC-60	Ø6mm platform Compact conical abutments	

Procedure for use:

The scan flag can be scanned directly on the implant with an intraoral scanner or indirectly on a model. Scan flags are used with digital libraries available for 3Shape, Exocad, and/or Dental Wings. A scan flag is attached to the implant or analogue before scanning to provide the exact orientation of the dental implant in the software.

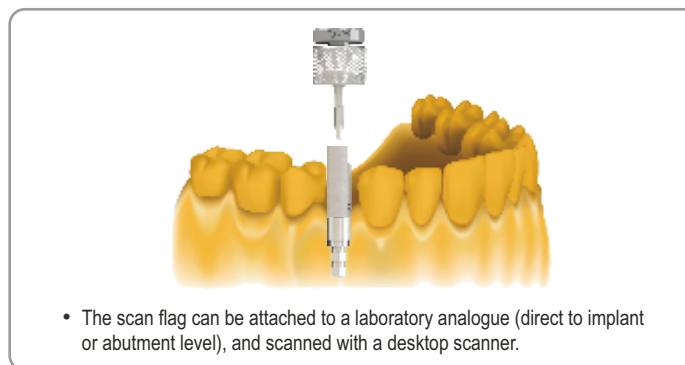
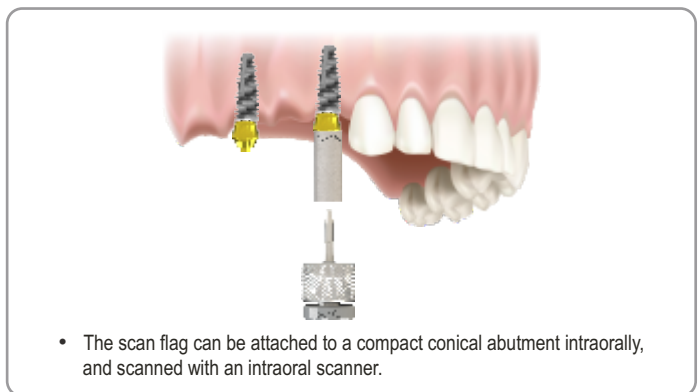
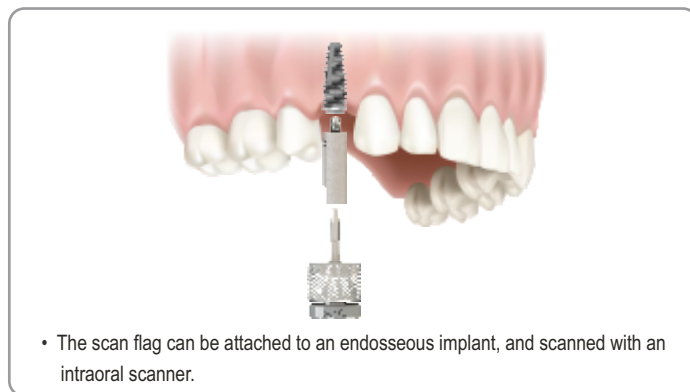

- Before placing the scan flag, ensure all items are clean and suitable for intraoral use. If the item is being "re-used", inspect the fitting surface to ensure
 - that there is no damage.
- Attach the correct Scan flag to the dental implant, abutment or lab analogue. Check that a proper fit is obtained, and hand tighten the screw with the appropriate driver.
- The patient is scanned with the scan flag attached to an implant, using an intraoral scanner. The laboratory model is scanned with the scan flag attached to the laboratory analogue, using a desktop scanner.
- The scan flag is removed from the implant or analogue.
- The scan flag in the digital format is now matched and aligned with the corresponding scan flag from the library file.
- The software recognizes the orientation of the scan flag to the implant or analogue. This allows the software to know where to place the abutment for the design stage.

Note: Follow the instructions of the scanner used, and for scanning procedures.

Materials:

Scan flag: Titanium

Screw: Titanium Grade 4 (anodized)

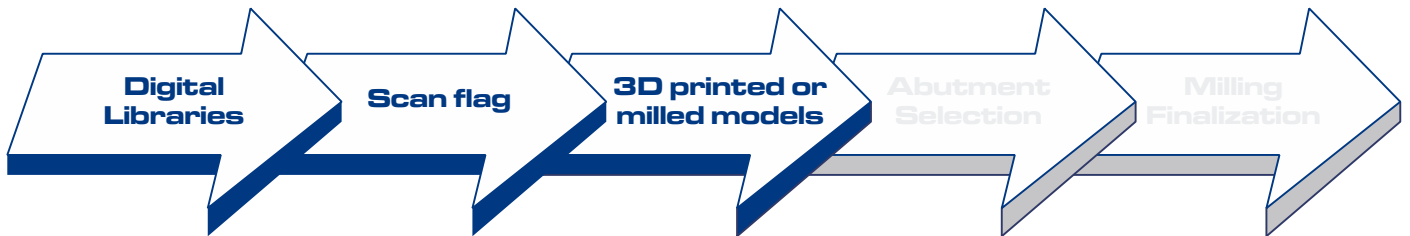

LABORATORY ANALOGUES

Intended use







Southern Implants' digital laboratory analogues are intended to be used as dental implant replicas that has to be inserted into a 3D printed or a milled model in order to duplicate the location, orientation, and restorative platform of the implant placed in the mouth during CAD/CAM procedures.

Description





Digital laboratory analogues are pre-manufactured components and are available in different connections. The items are to be fitted into a 3D printed or a milled model. Digital analogues are manufactured from Titanium, and are a two-piece component. The main component is anodized to match the prosthetic diameter of the implant being restored, and is supplied with a screw to secure the seat of the analogue in the model.

NOTE: Southern Implants digital analogues are for single use only. Re-use of the analogue can result in loss of accuracy.





EXTERNAL HEX

	Order Number	Scan flag	to be used with	Driver
	LAD-IP	SFT-EX-30	Ø3.0mm External Hex implant	 I-HD-M (1.22 hex)
	LAD-IBN	SFT-EX-34	Ø3.25mm External Hex implant	
	LAD-IB	SFT-EX-40	Ø4mm External Hex implant & MAX-6	
	LAD-BA	SFT-EX-50	Ø5mm External Hex implant & MAX-7	
	LAD-BBB	SFT-EX-60	Ø6mm External Hex implant & MAX-8	





TRI-NEX

	Order Number	Scan flag	to be used with	Driver
	LAD-L-35	SFT-EL-35	Ø3.5mm TRI-NEX implant	 I-HD-M (1.22 hex)
	LAD-L-43	SFT-EL-43	Ø4.3mm TRI-NEX implant	
	LAD-L-50	SFT-EL-50	Ø5mm TRI-NEX implant & TRI-MAX-7	
	LAD-L-60	SFT-EL-60	Ø6mm TRI-NEX implant & TRI-MAX-8 & 9	



DC RANGE

	Order Number	Scan flag	to be used with	Driver
	LAD-DC3	SFT-DC3	Ø3mm Deep Conical implant	
	LAD-DC4	SFT-DC4	Ø3.5mm & Ø4mm Deep Conical implant	
	LAD-DC5	SFT-DC5	Ø5mm Deep Conical implant	



INTERNAL HEX RANGE (M-SERIES & PROVATA®)

	Order Number	Scan flag	to be used with	Driver
	LAD-M	SFT-M	Ø3.7mm / Ø4.2mm / Ø5mm Internal Hex implants (M-series) Ø4mm / Ø5mm Provata Ø6mm PROMAX implants	
	LAD-M-P45	SFT-M	Ø5mm Provata & Ø6mm PROMAX implants	
	LAD-Z	SFT-Z	Ø7mm / Ø8mm / Ø9mm PROMAX implants	

IT (INTERNAL OCTAGON) RANGE

	Order Number	Scan flag	to be used with	Driver
	LAD-ITS	SFT-IT	Ø4.8mm IT implants & MAXIT7	
	LAD-IT6	SFT-IT6	Ø6.5mm IT implants & MAXIT8 & 9	

ABUTMENT LEVEL (COMPACT CONICAL ABUTMENT)

	Order Number	Scan flag	to be used with	Driver
	LAD-MC	SFT-MC-48	Ø4.8mm platform Compact conical abutments	
	LAD-MCW	SFT-MC-60	Ø6mm platform Compact conical abutments	

Procedures:

1. The implant position is obtained digitally by an intraoral scan of the patient with the scan flag attached to the implant.
2. Remove the scan flag from the implant/s, and replace with healing abutment/s.
3. The scan is then imported into the design software.

Design procedures:

4. The scan flag in the digital form is now matched and aligned with the corresponding scan flag in the library.
5. Model design software is chosen and the digital laboratory analogue is positioned digitally in the model.
6. The software will guide the user through the steps to design and complete the model.

Milling Procedures:

7. The digital stl file of the model is sent to a 3d printer or a milling machine to print/mill.
8. The digital analogues are inserted from the top into the open channel of the 3d printed/milled model. A soft tissue model is always recommended.
9. The model is turned upside down, and the screw is inserted apically and finger tightened with a 1.22mm hex driver to the analogue. This will secure the analogue into the printed or milled model.

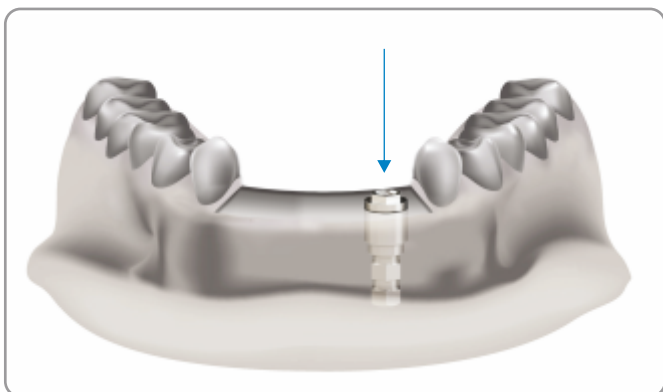

The digital analogue is inserted into the channel from the top of the model.

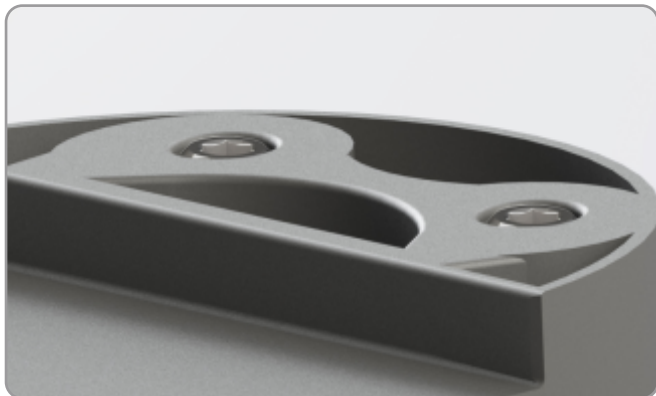

The model is turned upside down and a hex driver (I-HD-S/M/L) is used to secure the analogue to the model with the analogue screw.

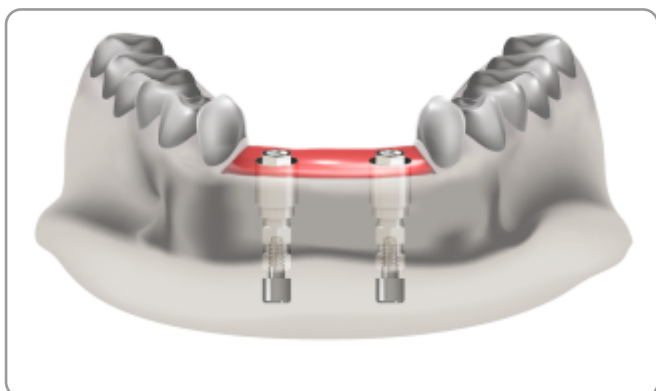

Completed soft tissue model with apical screws inserted into the model.

Notes:

- The digital analogue must be used with the corresponding digital analogue in the libraries.
- The screw must not be torqued – only finger tightened.

Material:

Digital lab analogue: Titanium

Digital lab analogue screw: Stainless steel

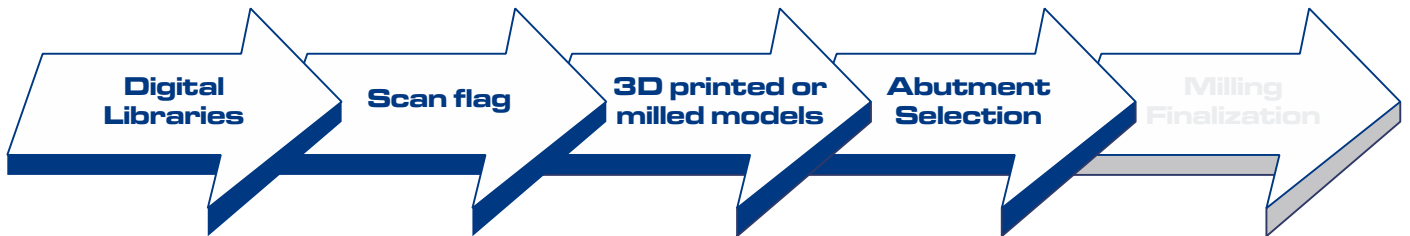





CIA ABUTMENTS









The Concept

The CIA Abutment was originally designed for use during direct scanning procedures with CAD/CAM systems as a screw channel could not be added during the design procedures (thus the need for the PEEK pin). In modern systems, this function is readily available and the PEEK pin can be discarded. The CIA Abutment features a unique narrow platform with a sandblasted surface to aid in retention during cementation procedures.

EXTERNAL HEX

Order Number		to be used with		Scan flag	Prosthetic screw options	Retaining screw torque
<small>Engaging</small>	<small>Non-Engaging</small>				1.22 Hex	
	CIA-EX-34		CIA-NX-34	Ø3.25mm External Hex implant	SFT-EX-34	
	CIA-EX-40		CIA-NX-40	Ø4mm External Hex implant & MAX-6	SFT-EX-40	3 Series Titanium & Gold Alloy screw (Refer to Catalogue for codes & Instrument detail)
	CIA-EX-50		CIA-NX-50	Ø5mm External Hex implant & MAX-7	SFT-EX-50	
	CIA-EX-60		CIA-NX-60	Ø6mm External Hex implant & MAX-8	SFT-EX-60	

TRI-NEX



Order Number		to be used with		Scan flag	Prosthetic screw options	Retaining screw torque
<small>Engaging</small>	<small>Non-Engaging</small>				Unigrip	
	CIA-EL-35		CIA-NL-35	Ø3.5mm TRI-NEX implant	SFT-EL-35	32Ncm
	CIA-EL-43		CIA-NL-43	Ø4.3mm TRI-NEX implant	SFT-EL-43	
	CIA-EL-50		CIA-NL-50	Ø5mm TRI-NEX implant & TRI-MAX-7	SFT-EL-50	32-40Ncm
	CIA-EL-60		CIA-NL-60	Ø6mm TRI-NEX implant & TRI-MAX-8 & 9	SFT-EL-60	

CAB ABUTMENTS





The Concept

The CAB Abutment was designed for Internal Hex (M-Series & Provata) and DC implant systems. These newer implant systems came in during the age of Digital dentistry. The concept of the CAB abutment is to be used with CAD/CAM systems where the screw access hole can be created in the design steps. This eliminates the need for a PEEK scanning pin as with the CIAAbutment.

DC RANGE

Order Number	to be used with	Scan flag	Abutment screw options	Final screw torque
			1.22 Hex	
 CAB-DC3	Ø3mm Deep Conical implant	SFT-DC3	TS-DC3-14	15Ncm
 CAB-DC4	Ø3.5mm & Ø4mm Deep Conical implant	SFT-DC4	TS-DC4-16	20Ncm
 CAB-DC5	Ø5mm Deep Conical implant	SFT-DC5	TS-DC5-20	25-32Ncm

INTERNAL HEX RANGE (M-SERIES & PROVATA®)

Order Number	to be used with	Scan flag	Abutment screw options	Final screw torque
		1.27 Hex (Titanium) Torx (Gold)		
 CAB-M	 CAB-NM	SFT-M	TS-Z-18	32Ncm
Ø3.7mm / Ø4.2mm / Ø5mm Internal Hex implants (M-series)				
Ø4mm / Ø5mm Provata				
Ø6mm PROMAX implants				
 CAB-M-P45	Ø5mm Provata & Ø6mm PROMAX implants		GS-Q-18	
 CAB-Z	Ø7mm / Ø8mm / Ø9mm PROMAX implants	SFT-Z		

Description

CAB Abutments are pre-manufactured components which are available in engaging and non-engaging versions for the standard platform internal hex abutments. The CAB Abutment is made from Titanium and anodized yellow. The abutment has retention grooves to aid in retention during cementation procedures. These abutments are connected directly to an endosseous implant, aiding in prosthetic rehabilitation.



CAB-M

For single unit restorations, the anti-rotational aspect is inside the restoration. An advantage is that emergence profiles can be created from the abutment platform.



CAB-NM

For multiple unit restorations there is no anti-rotational aspect

Material:

CAB Abutment: Titanium or Titanium alloy (Ti-6AL-4V)

Abutment screws: Titanium alloy Ti-90%, Al-6%, V-4% or Gold alloy Au-61%, Ag-16.5%, Pt-13.5%, Cu -9%

TIB ABUTMENTS

The Concept

The TIB Abutment was designed for use with SIRONA (CEREC) systems. The TIB Abutment range is also used with digital libraries in 3Shape, Exocad, and/or Dental Wings. This makes the TIB Abutment the most extended CAD/CAM abutment solution at Southern Implants. Each abutment is available in 3 different collar heights as well as being available in engaging and non-engaging versions.

Note: Screws sold separately for all abutments. TIB Abutments are **not available** for Ø3 DC implants and Ø3mm External Hex implants.

EXTERNAL HEX

Order Number			to be used with	Scan flag	3rd party Scan Body	Abutment screw	3rd party Software Selection
0.6mm	Collar Height 1.5mm	3mm					
Engaging			Ø3.25mm External Hex implants	SFT-EX-34	L	TSHZ3 (3 Series screws. Refer to CAT-2020 for codes & instrument information)	BO 3.4L
TIB-EX-34	TIB-EX-34-C1.5	TIB-EX-34-C3					
							
Non-Engaging							
TIB-NX-34	TIB-NX-34-C1.5	TIB-NX-34-C3					
							
Engaging			Ø4mm External Hex implant & MAX-6	SFT-EX-40	L	TSHZ3 (3 Series screws. Refer to CAT-2020 for codes & instrument information)	BO 4.1L
TIB-EX-40	TIB-EX-40-C1.5	TIB-EX-40-C3					
							
Non-Engaging							
TIB-NX-40	TIB-NX-40-C1.5	TIB-NX-40-C3					
							
Engaging			Ø5mm External Hex implant & MAX-7	SFT-EX-50	L	TSHZ3 (3 Series screws. Refer to CAT-2020 for codes & instrument information)	BO 5.0L
TIB-EX-50	TIB-EX-50-C1.5	TIB-EX-50-C3					
							
Non-Engaging							
TIB-NX-50	TIB-NX-50-C1.5	TIB-NX-50-C3					
							
Engaging			Ø6mm External Hex implant & MAX-8	SFT-EX-60	L	TSHZ3 (3 Series screws. Refer to CAT-2020 for codes & instrument information)	NB RS 6.0L
TIB-EX-60	TIB-EX-60-C1.5	TIB-EX-60-C3					
							
Non-Engaging							
TIB-NX-60	TIB-NX-60-C1.5	TIB-NX-60-C3					
							

TRI-NEX

Order Number			to be used with	Scan flag	3rd party Scan Body	Abutment screw	3rd party Software Selection
0.6mm	Collar Height 1.5mm	3mm					
Engaging			Ø3.5mm TRI-NEX implant	SFT-EL-35	L	TS-L-18 TS-L-18C GS-L-18	NB RS 3.5L
TIB-EL-35	TIB-EL-35-C1.5	TIB-EL-35-C3					
Non-Engaging			Ø3.5mm TRI-NEX implant	SFT-EL-35	L	TS-L-18 TS-L-18C GS-L-18	NB RS 3.5L
TIB-NL-35	TIB-NL-35-C1.5	TIB-NL-35-C3					
Engaging			Ø4.3mm TRI-NEX implant	SFT-EL-43	L	TS-L-20 TS-L-20C GS-L-20	NB RS 4.3L
TIB-EL-43	TIB-EL-43-C1.5	TIB-EL-43-C3					
Non-Engaging			Ø4.3mm TRI-NEX implant	SFT-EL-43	L	TS-L-20 TS-L-20C GS-L-20	NB RS 4.3L
TIB-NL-43	TIB-NL-43-C1.5	TIB-NL-43-C3					
Engaging			Ø5mm TRI-NEX implant & TRI-MAX-7	SFT-EL-50	L	TS-L-20 TS-L-20C GS-L-20	NB RS 5.0L
TIB-EL-50	TIB-EL-50-C1.5	TIB-EL-50-C3					
Non-Engaging			Ø5mm TRI-NEX implant & TRI-MAX-7	SFT-EL-50	L	TS-L-20 TS-L-20C GS-L-20	NB RS 5.0L
TIB-NL-50	TIB-NL-50-C1.5	TIB-NL-50-C3					
Engaging			Ø6mm TRI-NEX implant & TRI-MAX-8 & 9	SFT-EL-60	L	TS-L-20 TS-L-20C GS-L-20	NB RS 6.0L
TIB-EL-60	TIB-EL-60-C1.5	TIB-EL-60-C3					
Non-Engaging			Ø6mm TRI-NEX implant & TRI-MAX-8 & 9	SFT-EL-60	L	TS-L-20 TS-L-20C GS-L-20	NB RS 6.0L
TIB-NL-60	TIB-NL-60-C1.5	TIB-NL-60-C3					

TIB ABUTMENTS













DC-RANGE (DEEP CONICAL)

Order Number			to be used with	Scan flag	3rd party Scan Body	Abutment screw	3rd party Software Selection
0.6mm	Collar Height 1.5mm	3mm					
Engaging			Ø3.5 & Ø4.0 DC implants	SFT-DC4	L	TS-DC4-16	AT OS 3.5/4.0L
TIB-DC4	TIB-DC4-C1.5	TIB-DC4-C3					
Non-Engaging						Final torque 20Ncm	
TIB-NDC4	TIB-NDC4-C1.5	TIB-NDC4-C3					
Engaging			Ø5.0 DC implants	SFT-DC5	L	TS-DC5-20	AT OS 4.5/5.0L
TIB-DC5	TIB-DC5-C1.5	TIB-DC5-C3					
Non-Engaging						Final torque 25-32Ncm	
TIB-NDC5	TIB-NDC5-C1.5	TIB-NDC5-C3					

INTERNAL HEX RANGE (M-SERIES & PROVATA®)

Order Number			to be used with	Scan flag	3rd party Scan Body	Abutment screw	3rd party Software Selection
0.6mm	Collar Height 1.5mm	3mm					
Engaging			Ø3.7mm / Ø4.2mm / Ø5mm Internal Hex implants (M-series)	SFT-M	L	TS-Z-18 GS-Q-18	NB RS 4.3L
TIB-M	TIB-M-C1.5	TIB-M-C3					
Non-Engaging			Ø4mm/Ø5mm Provata			Final torque 32Ncm	
TIB-NM	TIB-NM-C1.5	TIB-NM-C3	Ø5mm Provata & Ø6mm PROMAX implants				
Engaging			Ø5mm Provata & Ø6mm PROMAX implants	SFT-M	L	TS-Z-18 GS-Q-18	NB RS 4.3L
TIB-M-P45							
Engaging			Ø7mm / Ø8mm / Ø9mm PROMAX implants	SFT-Z	L	TS-Z-18 GS-Q-18	B0 5.0L
TIB-Z	TIB-Z-C1.5	TIB-Z-C3					
Non-Engaging						Final torque 32Ncm	
TIB-NZ	TIB-NZ-C1.5	TIB-NZ-C3					

IT (INTERNAL OCTAGON)

Order Number			to be used with	Scan flag	3rd party Scan Body	Abutment screw	3rd party Software Selection
0.6mm	Collar Height 1.5mm	3mm					
Engaging			ø4.8mm IT implants & MAXIT7	SFT-IT	L	TS-IT-TIB	NB RS 4.3L
TIB-ITS	TIB-ITS-C1.5	TIB-ITS-C3					
							
Non-Engaging							
TIB-ITSNE	TIB-ITSNE-C1.5	TIB-ITSNE-C3					
							
Engaging			Ø6mm IT implants & MAXIT8 & 9	SFT-IT6	L	TS-IT-TIB	NB RS 6.0L
TIB-IT6	TIB-IT6-C1.5	TIB-IT6-C3					
							
Non-Engaging							
TIB-IT6NE	TIB-IT6NE-C1.5	TIB-IT6NE-C3					
							

Note: refer to product catalogue for available instruments and screw types.

Illustration to show different collar heights

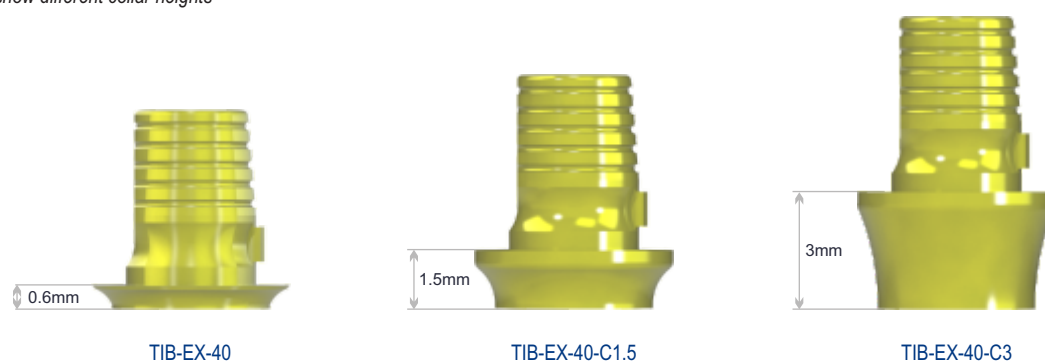

Note: The diameter of the TIB Abutment must not be reduced. Shortening of the TIB is not permitted when used with Sirona.

TIB ABUTMENTS

Description

TIB Abutments are pre-manufactured components which are available in engaging and non-engaging versions for different connection systems. The TIB Abutment is made from Titanium and is anodized yellow. It is available in a 0.6mm, 1.5mm, and 3mm collar height. The abutment has retention grooves to aid in retention during cementation procedures. These abutments are connected directly to an endosseous implant for aiding in prosthetic rehabilitation.



TIB-EX-40

For single unit restorations, the anti-rotational aspect is inside the restoration. An advantage is that emergence profiles can be created from the abutment platform.



TIB-NX-40

For multiple unit restorations there is no anti-rotational aspect

Material:

TiB Abutment: Titanium or Titanium alloy (Ti-6AL-4V)

Abutment screws: Titanium alloy (Ti-90%, Al-6%, V-4%) or Gold alloy (Au-61%; Ag-16.5%; Pt-13.5%; Cu-9%)

CIA, CAB, and TIB Abutments using SIDigital libraries

- Download Southern Implants' digital library for 3Shape, Exocad, and/or Dental Wings by registering on www.southernimplants.com
- Load the libraries into the CAD/CAM system by following their instructions.
- The implant position is obtained digitally either by an intraoral scan of the patient with scan flags attached to the endosseous implant, or a desktop scan of the dental model with the scan flags attached to the laboratory analogue.
- Remove the scan flag from the implants or from the model. (Replace it with healing abutments if used intra-orally).
- The scan is then imported into the design software.
- The scan flag in the digital form is now matched and aligned with the corresponding scan flag in the library.



- The software recognizes the position of the Scan flag to the implant/s or analogue/s as well as where to place the analogues/abutment for the design steps.
- For a printed/milled model, model design software is used and the digital laboratory analogues are positioned digitally in the model.
- The software will guide the user through the steps to design and complete the model.
- The digital analogues are then inserted into the model.

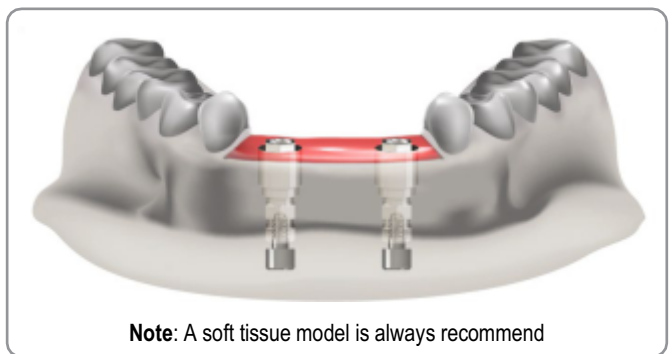

- The abutment/s is chosen from the library. The user will determine the desired tooth or teeth positions needed for the abutment/s, and the path of insertion will be determined. This will govern if a screw retained or cemented restoration is possible.

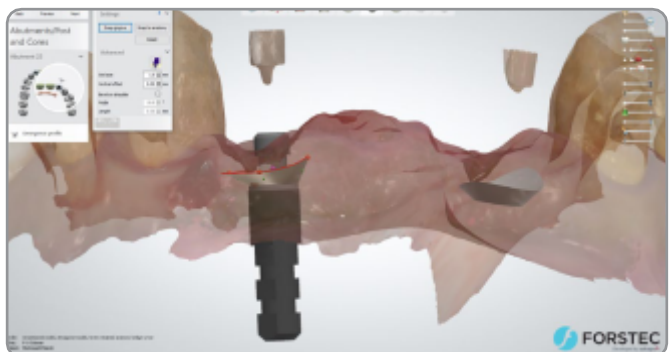
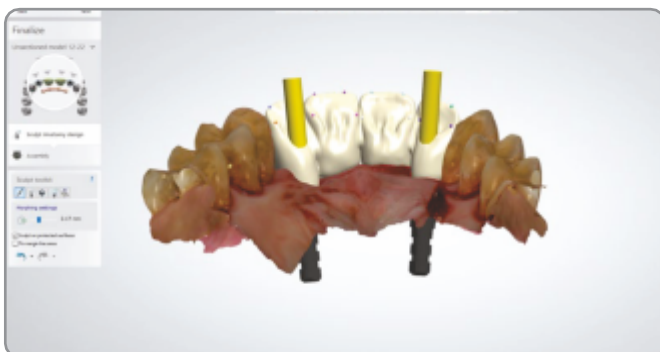

PROCEDURES FOR USE

- The software will guide the user through the steps to complete the restoration. Selection of the relevant restorative material will then be required; the most common material to use is Zirconia.
- The restoration design is completed and the design file is sent to a milling unit or a production facility.
- The milled component/s is to be sintered to the specifications of the manufacturer if Zirconia is used. Once sintered, the abutment, the custom abutment or restoration is cemented to the prefabricated Titanium abutment by closing the screw channel temporarily to keep the screw channel free of cement.

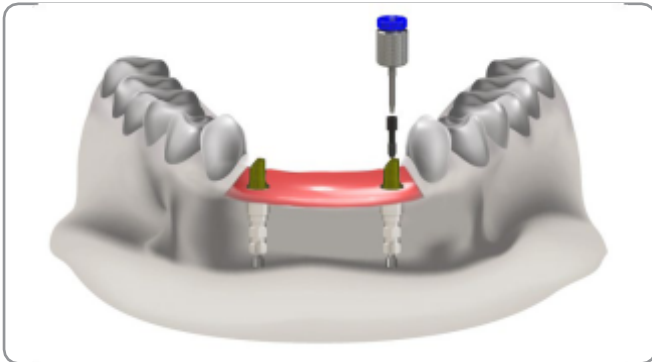

Finishing procedures:

Polishing Protector Caps

These items are used to protect the interface and edges of various components, milled structures, and abutments when polishing. They are attached to the relevant abutments using the appropriate laboratory screw. Polishing then commences according to standard laboratory procedures. (Refer to page 96 for information available for Polishing Protector Caps).

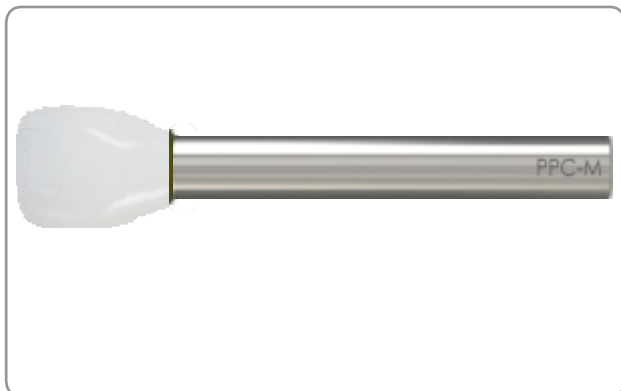

Final Clinical procedures:

1. Clean and disinfect the restoration as applicable per the restorative material manufacturer's instructions.
2. a. For screw retained unit/s: Place and tighten the restoration screw. Verify the correct seating of the restoration using radiographic imaging. Tighten the restoration, using a torque wrench, to the specified torque value for the applicable prosthetic screw.
b. For cement retained unit/s: Place and tighten the restoration screw. Verify the correct seating of the substructure/custom post using radiographic imaging. Tighten the abutment with the substructure/custom post, using a torque wrench, to the specified torque value for the applicable prosthetic screw. Close the screw access holes and cement the final prosthesis in place.

TIB abutments used with Sirona

Scanning procedure:

1. Use the corresponding third party Scan body as indicated on pages 30 to 33 or the Workflow from page 49.
2. Choose either the white or grey Scan body – depending on the Cerec scanner (refer to Cerec manuals for more detail).
3. Align the guide grooves in the Scan body with the TIB Abutment and make sure that it seats flush without any gaps.

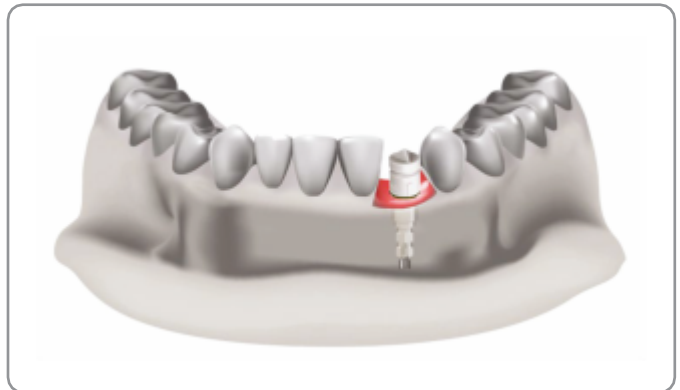
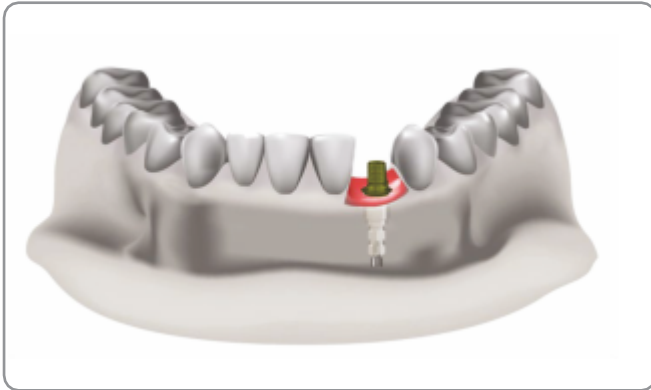

4. Select the correct scan body and corresponding TiBase in the software.
5. Take a scan with your scanner like normal. Ensure that the top of the scan body is completely captured.
6. **Note:** The diameter of the TIB Abutment must not be reduced. Shortening of the TIB is not permitted.
7. The software will guide the user to design the shape of the restoration.

Milling Procedures:

1. Mill the shape from meso block size L (see the "InLab 3D for Abutment User Manual").
2. Carefully follow the instructions and information in the operating instructions for meso blocks.
3. Send the design files to a milling unit or production facility accepting Sirona designs, or send the design to your InLab specialist.

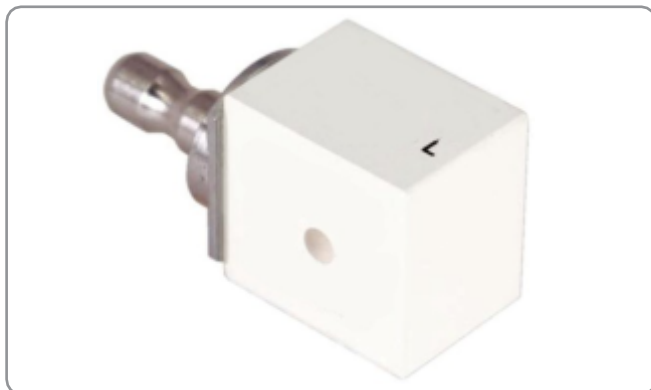









PASSIVE ABUTMENTS









The Concept:

The Passive Abutment concept allows one to achieve predictable passive fit of milled structures in a practical and repeatable way and thus eliminates the need for complex and intensive laboratory procedures usually undertaken to improve the fit. The Passive fit is achieved by luting a pre-machined Titanium interface component into the finished prosthesis, using the laboratory master model as the blueprint for fit. No additional clinical steps are required.







EXTERNAL HEX

Order Number		to be used with	Scan flag	Abutment screw	Final torque
Engaging SP16 	Non-Engaging SP17 	Ø3mm External Hex implants	SFT-EX-30	TS-P-16	25-32Ncm
Engaging SBN16 	Non-Engaging SBN-17-TT 	Ø3.4mm External Hex implants	SFT-EX-34		
Engaging SB16 	Non-Engaging SB-17-TT 	Ø4mm External Hex implant & MAX-6	SFT-EX-40	2 Series screws (Refer to CAT-2020 for codes & instrument information)	32-40Ncm
Engaging SBA16 	Non-Engaging SBA-17-TT 	Ø5mm External Hex implant & MAX-7	SFT-EX-50		
Engaging SBBB16 	Non-Engaging SBBB-17-TT 	Ø6mm External Hex implant & MAX-8	SFT-EX-60		





TRI-NEX

Order Number		to be used with	Scan flag	Abutment screw	Final torque
Engaging PA-EL-35 	Non-Engaging PA-NL-35 	Ø3.5mm TRI-NEX implant	SFT-EL-35	PA-L-18 PA-L-18G	32Ncm
Engaging PA-EL-43 	Non-Engaging PA-NL-43 	Ø4.3mm TRI-NEX implant	SFT-EL-43		32-40Ncm
Engaging PA-EL-50 	Non-Engaging PA-NL-50 	Ø5mm TRI-NEX implant & TRI-MAX-7	SFT-EL-50	PA-L-20 PA-L-20G	
Engaging PA-EL-60 	Non-Engaging PA-NL-60 	Ø6mm TRI-NEX implant & TRI-MAX-8 & 9	SFT-EL-60		





DC-RANGE (DEEP CONICAL)

Order Number		to be used with	Scan flag	Abutment screw	Final torque
Engaging PA-DC3 	Non-Engaging PA-NDC3 	Ø3mm Deep conical implant	SFT-DC3	PA-DC3-14T	15Ncm
Engaging PA-DC4 	Non-Engaging PA-NDC4 	Ø3.5 & 4mm Deep conical implant	SFT-DC4	PA-DC4-16T	20Ncm
Engaging PA-DC5 	Non-Engaging PA-NDC5 	Ø5mm Deep conical implant	SFT-DC5	PA-DC5-20T	25-32Ncm



INTERNAL HEX RANGE (M-SERIES & PROVATA®)

Order Number		to be used with	Scan flag	Abutment screw	Final torque
Engaging PA-EM-S 	Non-Engaging PA-NM-S 	Ø3.7mm / Ø4.2mm / Ø5mm Internal Hex implants (M-series)	SFT-M		
		Ø4mm/Ø5mm Provata Ø5mm Provata & Ø6mm PROMAX implants			
Engaging PA-EM-SP45 		Ø6mm PROMAX implants		PA-Z-18T PA-Q-18G	32Ncm
Engaging PA-EZ 	Non-Engaging PA-NZ 	Ø7mm /Ø8mm /Ø9mm PROMAX implants	SFT-Z		

IT (INTERNAL OCTAGON) RANGE

Order Number		to be used with	Scan flag	Abutment screw	Final torque
Engaging ITS-PA 	Non-Engaging ITS-PA-NE 	Ø4.8mm IT implants & MAXIT7	SFT-IT	TS-IT-PA	32-40Ncm
Engaging ITS6-PA 	Non-Engaging ITS6-PA-NE 	Ø6mm IT implants & MAXIT8 & 9	SFT-IT6		

ABUTMENT LEVEL (COMPACT CONICAL ABUTMENT)

Order Number		to be used with	Scan flag	Abutment screw	Final torque
Engaging PA-MC-48 		Ø4.8mm Comp Conical	SFT-MC-48	1 Series Titanium screws. (Refer to catalogues for codes & instrument information)	10-15Ncm
Engaging PA-MC-60 		Ø6mm Comp Conical	SFT-MC-60		

Description

Passive Abutments are pre-manufactured for aiding prosthetic rehabilitation. These abutments are connected directly to an endosseous implant, or connect the prosthesis to a compact conical abutment.

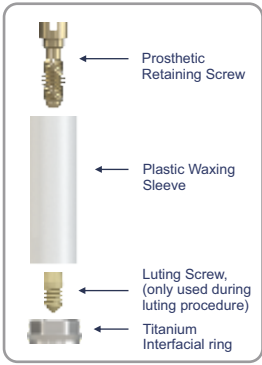

Detailed Description

The Passive Abutment consists of four components:

1. Plastic cylinder – this component is not used during CAD/CAM procedures.
2. Titanium interfacial component/abutment –this pre-machined component forms the final interface between the milled restoration and the implant.
3. Luting screw –this small screw is used to clamp the interfacial component onto the laboratory analogue during the process of luting the casting onto the interfacial component. The component is not used clinically.
4. Prosthetic screw –this screw retains the completed prosthesis to the implant at final placement and provides a compressive force across the cement line.

NOTE: Only in the DC range is the prosthetic screw included, for all other systems the prosthetic screw is sold separately.

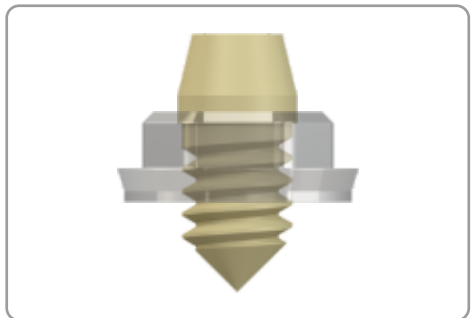
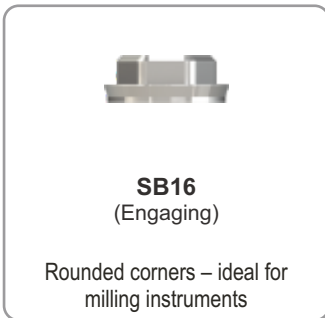

Materials:

- Passive Abutment: Titanium grade,2,3,4 or 5
 Plastic Sleeve: Polyoxymethylene (POM)
 Luting screw: Medical grade PEEK (DES-3000)
 Abutment screws: Titanium alloy Ti-90%, Al-6%, V-4% or Gold Alloy Au-61%, Ag-16.5%, Pt-13.5%, Cu -9%

Overview of Use:

- The passive abutment is selected in the software, and the restoration is designed and milled.
- The milled structure may then undergo further laboratory processing e.g. ceramic firing, finishing and polishing before being assembled with the interfacial component.
- The Passive Abutment (Titanium interfacial component) is kept separate from the manufacturing of the milled structure and is, therefore, not subjected to degradation by heat-cycles or finishing procedures. The integrity of the machined part maintains its original condition.
- The finished milled structure is assembled with the interfacial ring by luting the laboratory model, before placement in the patient's mouth. For assembly, the Titanium interfacial component is clamped to the analogue on the master model by means of the luting screw. The luting screw ensures that the interfacial component is held in full contact with the analogue.
- The finished prosthesis is then luted to the clamped interfacial ring using resin cement. In this way the resin cement serves as a space filler between the milled structure and the interfacial ring. This compensates for any minor fitting and finishing discrepancies, and eliminated any misfit of the milled structure to the implant.
- At placement in the mouth, the prosthetic screw retains the prosthesis to the implant and maintains a compressive force over the cement line. The cement line is, therefore, not responsible for retention of the prosthesis. It is merely a space filler. The luting screw is discarded after the luting procedure.

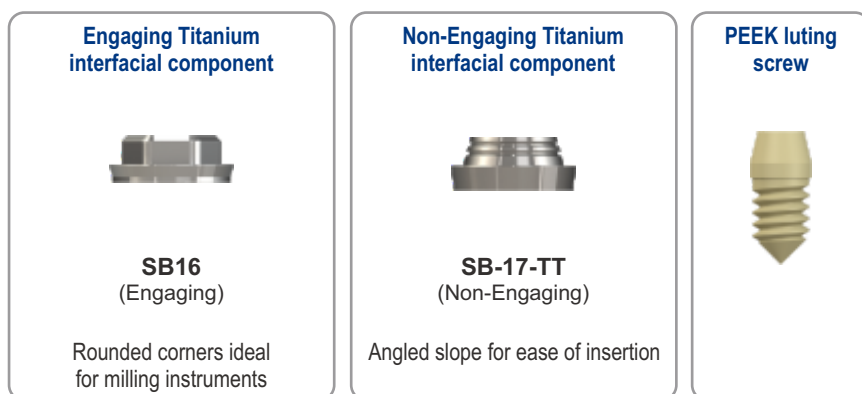

Digital workflow by using digital libraries

Scanning procedure:

1. Download Southern Implants digital library for 3Shape, Exocad, and/or Dental Wings by registering on www.southernimplants.com.
2. Load the libraries into the CAD/CAM system by following their instructions.
3. The implant position is obtained digitally either by an intraoral scan of the patient with scan flags attached to the endosseous implant/compact conical abutments, or a desktop scan of the dental model with the scan flags attached to the laboratory analogue.
4. The scan is then imported into the design software.

Designing procedures:

5. The scan flag in the digital form is now matched and aligned with the corresponding scan flag in the library.
6. The software recognizes the position of the scan flag to the implant or analogue.
7. The Passive abutment/s is chosen from the library. The user will determine the desired tooth or teeth positions needed for the abutment/s, and the path of insertion will be determined. This will govern if a screw retained or cemented restoration is possible.
8. The software will guide the user through the steps to complete the restoration.
9. Selection of the relevant restorative material will then be required; the most common material to use is Zirconia.

Milling & sintering procedures:

10. The milled custom abutment or screw retained restoration is to be sintered to the specifications of the manufacturer if Zirconia was used. Once sintered the restoration is cemented to the prefabricated Titanium Passive Abutment by following the following steps:

Luting procedures for Passive Abutments:

1. It is highly recommended to use a model with removable soft issue mask. This will allow easy access to the analogues for further lab procedures, and will greatly ease latter assembly and processing procedures.
2. The luting procedure and concept stays the same when using passive abutments on compact conical level, multiple unit restorations and single unit restorations. For illustration purposes the following steps will show the steps applicable to all.

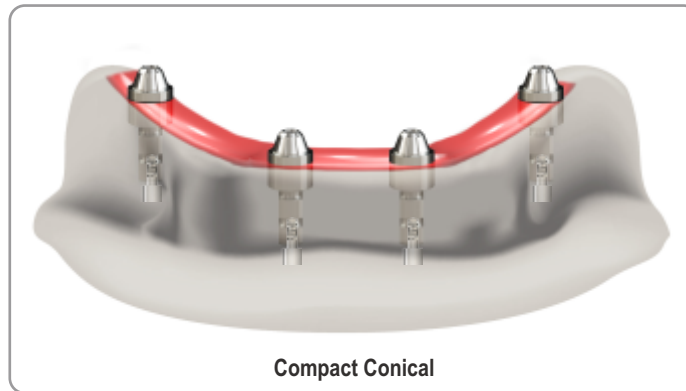
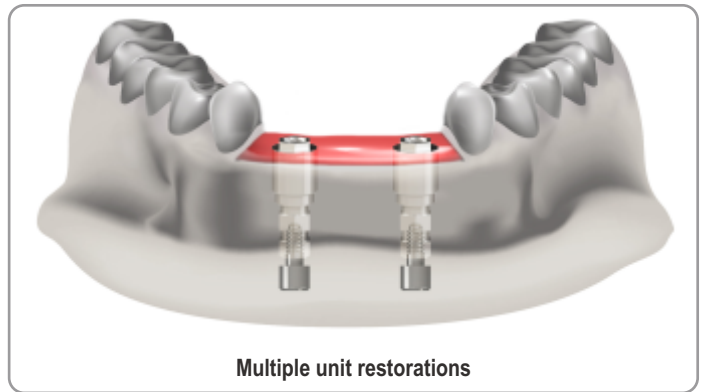
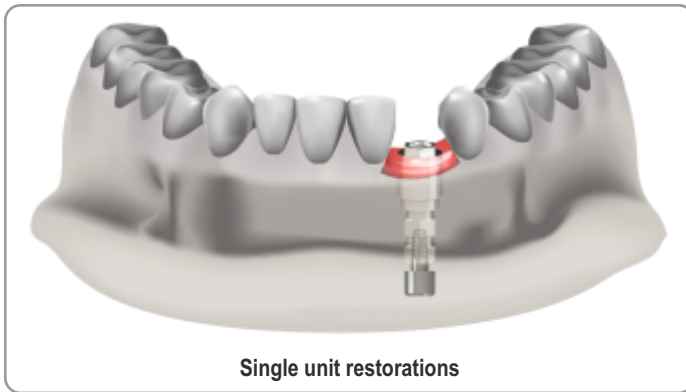

3. Finger-tighten, with the PEEK luting screw, the titanium interfacial component to the laboratory analogue. Using the corresponding driver as indicated on pages 38-39, and see page 76 for more driver information.

NOTE: Sandblasting of the Titanium interfacial component is not recommended as it rounds of the corners and the exact machined dimensions will be lost.

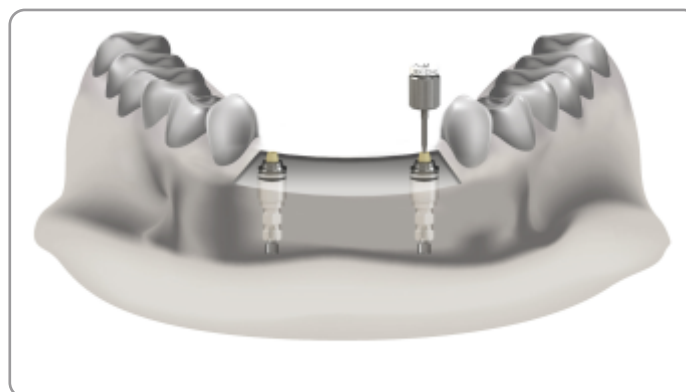

The milled structure can easily be fitted and removed from the interfacial abutment without the need to remove or replace the PEEK luting screw. This is due to the PEEK luting screw attaching the titanium interfacial abutment to the analogue, and not the milled structure to the analogue.

- If it is needed to screw retain the milled structure to the lab analogue to undertake further laboratory procedures, one of the PEEK luting screws can be removed and a laboratory screw can be used to attach the prosthesis to the master model. This will ensure that the prosthesis does not move during articulation, opposite set up, or any other laboratory procedures.

5. It is important to ultrasonically clean or steam clean the following before the luting procedure starts:
 - The titanium interfacial components
 - The short luting screws
 - The fitting surfaces of the prosthesis
 - Also clean the analogues (Implant Replicas) in the model by brushing with soap and water or steam cleaning to remove any debris which may interfere with perfect seating of the interfacial components.
6. Clean the restoration in an ultrasonic unit for about 1 minute. Dry it with oil-free air. Apply Monobond Plus (Ivoclar Vivadent) to the cleaned surfaces of the titanium interfacial component and restoration using a brush or microbrush. Allow the Monobond Plus to react for 60 seconds and disperse with compressed air.

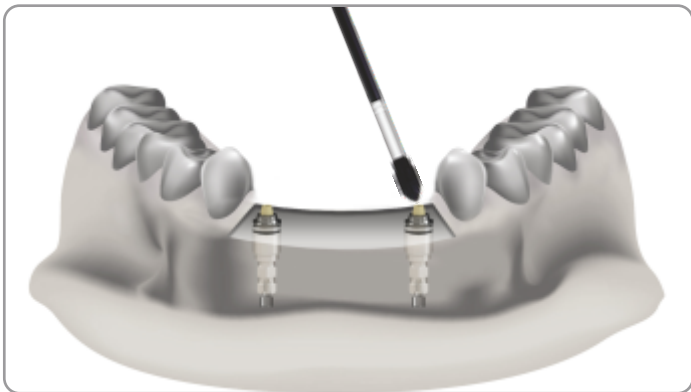

7. Lute the Titanium interfacial abutment to the milled structure by applying a self-cure resin cement or dual cure resin cement (e.g. Rely X by 3M) to the surface of all of the titanium rings. (NB: refrigeration of self-cure resin cements will usually lengthen working time for ease of use on multi-unit structures).

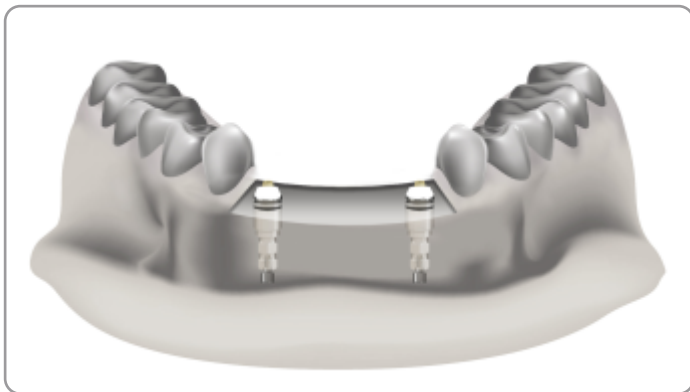
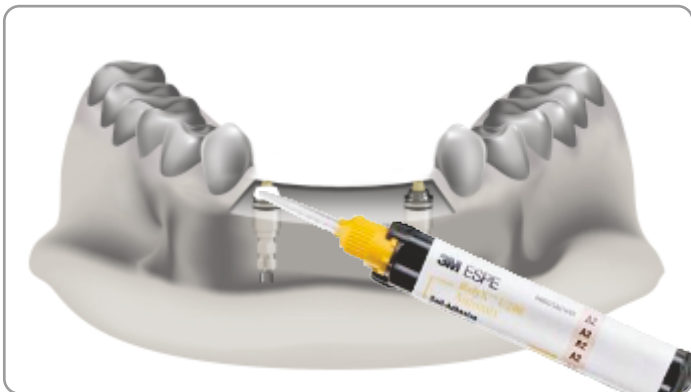

8. Limit the amount of resin cement being applied to the angle between the horizontal plane and vertical plane of the titanium ring. This will avoid excess cement extruding upwards through the screw hole in the milled structure and inadvertently locking the luting screw into the cement. Definitely avoid placing any cement in the area immediately around the head of the luting screw.

In the event that cement locks the luting screw in position, a diameter 1.5mm round burr is rotated into the hex of the screw. This usually separates the screw head from the shaft and frees the prosthesis. Take care not to damage the components. The prosthesis can then be removed.

- Fit the prosthesis over the titanium interfacial component/abutment and settle the prosthesis firmly into place with finger pressure to extrude excess cement. Arch milled structures can be left seated under their own weight to allow cement to harden. Light cure for 60 seconds, un-mount the restoration and remove excess cement using a sharp blade, probe, or hand scaler instrument to make polishing easier. (Extruded cement breaks away easily in large pieces from the outer polished surfaces of the structure and titanium ring).

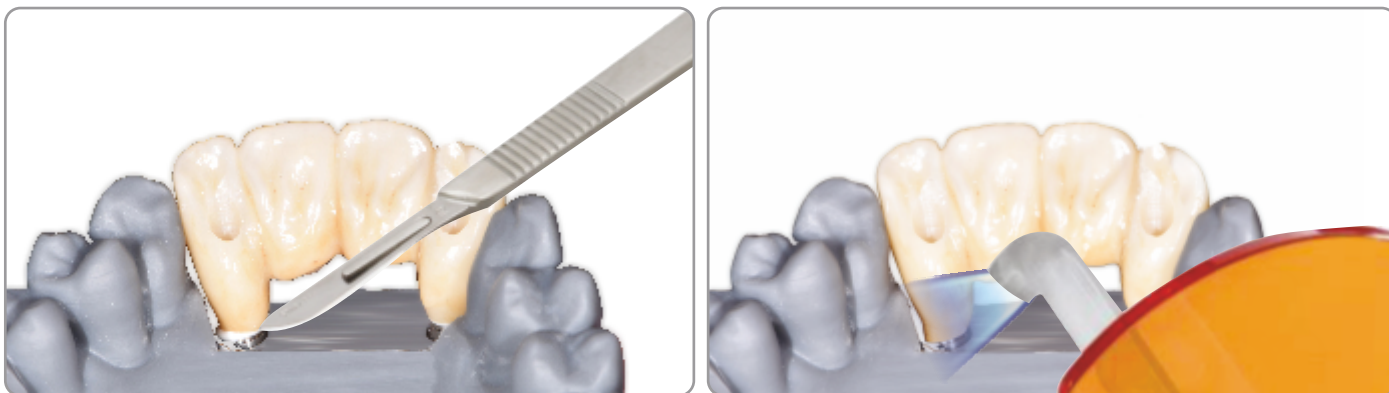

- Once resin cement has hardened, remove all luting screws and then remove any prosthetic retaining screws so that the prosthesis can be lifted from the model. Attach polishing protectors to each of the fitting surfaces of the cemented titanium interfacial component. Polish the remaining cement line using a fine-edged lens-shaped rubber wheel. You will notice that the cement line is often not of constant thickness. This variation is indicative of the extent of misfit which existed and has now been corrected by the cement space of the Passive Abutment. (This effect is not as prominent in milled structures as it is in conventional cast structures).

FINISHING PROCEDURES:

Polishing Protector Caps

These items are used to protect the interface and edges of various components, milled structures, and abutments when polishing. They are attached to the relevant Passive Abutments, using the appropriate laboratory screw. Polishing then commences according to standard laboratory procedures. (Refer to CAT-1010 for information on Polishing Protector Caps).

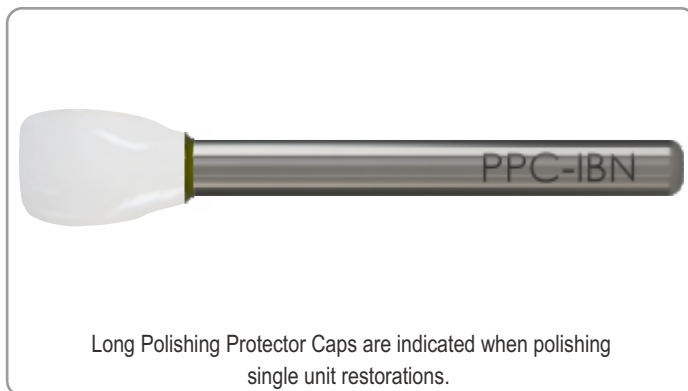

All caps are made from a hardened stainless steel to ensure longer life.

- Once polishing is completed, remove protector caps and replace the casting on the cleaned model analogues to inspect and verify the quality of fit obtained. (Resin cement is best cleaned from analogues using a brush with alcohol)

The fit would be expected to be excellent in all areas, but, in the unlikely event that a luting error has occurred, the offending titanium ring may be removed, cleaned and re-cemented to the prosthesis as required. A titanium ring can easily be removed by forcing a sharp blade into the cement line, or by punching out the ring using the shaft of a lab hand piece drill applied through the screw access hole (place the bridge rings down on a folded towel for padding and give the drill shaft a sharp tap).

VERY IMPORTANT: as this technique relies absolutely on the accuracy of the master model to achieve passive fit of the prosthesis, it is vital that accurate impression techniques be used and that the quality and condition of the model and analogues be maintained at all times.

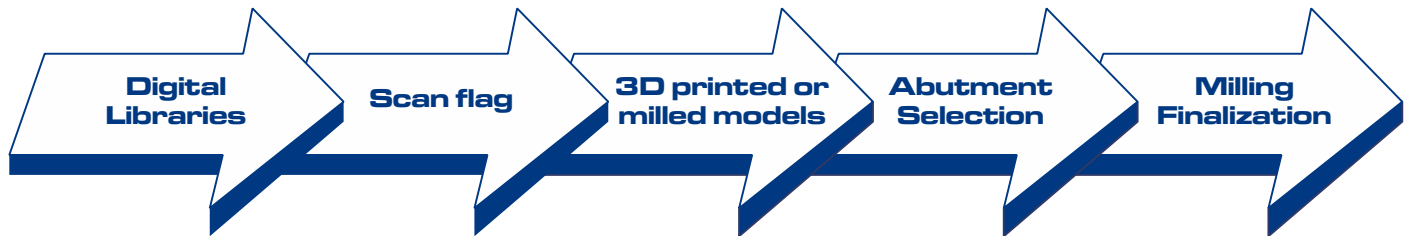

Milling & sintering procedures:

- The restoration design is completed and the design file is sent to a milling unit or a production facility.
- The milled component/s is to be sintered to the specifications of the manufacturer if Zirconia is used. Once sintered, the abutment, custom abutment, or restoration is cemented to the prefabricated Titanium abutment by closing the screw channel temporarily to keep the screw channel free of cement.
- The milled substructure milled is cemented onto the abutments and the final restoration constructed and cemented onto this.

FINISHING PROCEDURES:

Polishing Protector Caps

These items are used to protect the interface and edges of various components, milled structures, and abutments when polishing. They are attached to the relevant abutments, using the appropriate laboratory screw. Polishing then commences according to standard laboratory procedures. (Refer to CAT-1010 for information available for Polishing Protector Caps).

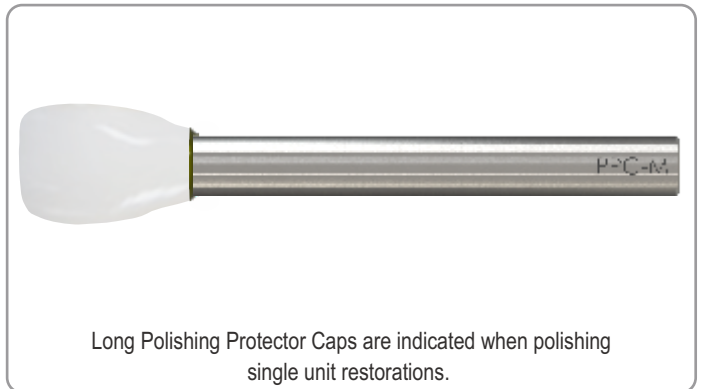
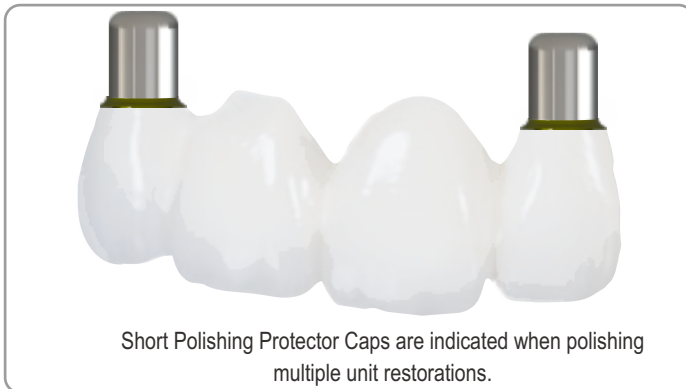

All caps are made from a hardened stainless steel to ensure longer life.

Final Clinical procedures:

1. Clean and disinfect the restoration as applicable per the restorative material manufacturer's instructions.
2. a. For screw retained unit/s: Place and tighten the restoration screw. Verify the correct seating of the restoration using radiographic imaging. Tighten the restoration, using a torque wrench, to the torque value specified for the applicable prosthetic screw.
b. For cement retained unit/s: Place and tighten the restoration screw. Verify the correct seating of the substructure/custom post using radiographic imaging. Tighten the substructure/custom post, using a torque wrench, to the torque value specified for the applicable prosthetic screw. Close the screw access holes and cement the final prosthesis in place.

WORKFLOWS

Direct

Implants



CODE	LENGTHS
IP-	8.5 / 10 / 11.5 / 13 / 15
MSc-IP-	8.5 / 10 / 11.5 / 13 / 15

Scanning Flag

SFT-EX-30



Digital Analogues

LAD-IP



Prosthetic Components

PASSIVE Abutment



SP16
SP17

Engaging
Non-Engaging

Software Selection

Main Selection
SI PASSIVE EXT-HEX

Secondary Selection
SP16 EN
SP17 NE

Retaining Screws

TS-P-16



Titanium
(M1.6mm,
1.22 Hexed)

Indirect

Compact Conical Abutment

APMC



1 / 3 / 4 / 5.5

SFT-MC-48



LAD-MC



PASSIVE Abutment
(Compact Conical)



PA-MC-48

Non-Engaging







Main Selection
SI PASSIVE
COMPACT CONICAL

Secondary Selection
PA-MC-48 NE

1 Series
Screws

Not available

Direct

Implants	Scanning Flag	Digital Analogues	Prosthetic Components	Software Selection	Retaining Screws																																
 <table border="1"> <thead> <tr> <th>CODE</th> <th>LENGTHS</th> </tr> </thead> <tbody> <tr> <td>IBN</td> <td>8.5 / 10 / 11.5 / 13 / 15 / 18</td> </tr> <tr> <td>IBNT</td> <td>8.5 / 10 / 11.5 / 13 / 15 / 18</td> </tr> <tr> <td>IBNT12d-</td> <td>8.5 / 10 / 11.5 / 13 / 15 / 18</td> </tr> <tr> <td>MSc-IBNT12d-</td> <td>8.5 / 10 / 11.5 / 13 / 15 / 18</td> </tr> </tbody> </table> <table border="1"> <thead> <tr> <th>CODE</th> <th>LENGTHS</th> </tr> </thead> <tbody> <tr> <td>IBR12d-</td> <td>8.5 / 10 / 11.5 / 13 / 15 / 18</td> </tr> <tr> <td>MSc-IBR12d-</td> <td>8.5 / 10 / 11.5 / 13 / 15 / 18</td> </tr> <tr> <td>IBR24d-</td> <td>8.5 / 10 / 11.5 / 13 / 15 / 18 / 20 / 22 / 24</td> </tr> <tr> <td>MSc-IBR24d-</td> <td>8.5 / 10 / 11.5 / 13 / 15 / 18 / 20 / 22 / 24</td> </tr> </tbody> </table> INVERTA® <table border="1"> <thead> <tr> <th>CODE</th> <th>LENGTHS</th> </tr> </thead> <tbody> <tr> <td>IV-EX35-45</td> <td>10 / 11.5 / 13 / 15</td> </tr> <tr> <td>IV-EX3512D-45</td> <td>11.5 / 13 / 15</td> </tr> </tbody> </table> <table border="1"> <thead> <tr> <th>CODE</th> <th>LENGTHS</th> </tr> </thead> <tbody> <tr> <td>IV-EX40-50</td> <td>10 / 11.5 / 13 / 15</td> </tr> <tr> <td>IV-EX4012D-50</td> <td>11.5 / 13 / 15</td> </tr> </tbody> </table>	CODE	LENGTHS	IBN	8.5 / 10 / 11.5 / 13 / 15 / 18	IBNT	8.5 / 10 / 11.5 / 13 / 15 / 18	IBNT12d-	8.5 / 10 / 11.5 / 13 / 15 / 18	MSc-IBNT12d-	8.5 / 10 / 11.5 / 13 / 15 / 18	CODE	LENGTHS	IBR12d-	8.5 / 10 / 11.5 / 13 / 15 / 18	MSc-IBR12d-	8.5 / 10 / 11.5 / 13 / 15 / 18	IBR24d-	8.5 / 10 / 11.5 / 13 / 15 / 18 / 20 / 22 / 24	MSc-IBR24d-	8.5 / 10 / 11.5 / 13 / 15 / 18 / 20 / 22 / 24	CODE	LENGTHS	IV-EX35-45	10 / 11.5 / 13 / 15	IV-EX3512D-45	11.5 / 13 / 15	CODE	LENGTHS	IV-EX40-50	10 / 11.5 / 13 / 15	IV-EX4012D-50	11.5 / 13 / 15	 SFT-EX-34	 LAD-IBN	<p>TIB Abutments</p>  TIB-EX-34 TIB-EX-34-C1.5 TIB-EX-34-C3 Engaging Engaging Engaging TIB-NX-34 Non-Engaging TIB-NX-34-C1.5 Non-Engaging TIB-NX-34-C3 Non-Engaging <p>CIA Abutments</p>  CIA-EX-34 Engaging CIA-NX-34 Non-Engaging <p>PASSIVE Abutment</p>  SBN16 Engaging SBN-17-TT Non-Engaging	<p>Main Selection SI TIB EXT-HEX</p> <p>Secondary Selection TIB-EX-34 EN TIB-EX-34-C1.5 EN TIB-EX-34-C3 EN TIB-NX-34 NE TIB-NX-34-C1.5 NE TIB-NX-34-C3 NE</p> <p>Main Selection SI CIA EXT-HEX</p> <p>Secondary Selection CIA-EX-34 EN CIA-NX-34 NE</p> <p>Main Selection SI PASSIVE EXT-HEX</p> <p>Secondary Selection SBN16 EN SBN-17-TT NE</p>	<p>3 Series Screws</p> <p>2 Series Screws</p>
CODE	LENGTHS																																				
IBN	8.5 / 10 / 11.5 / 13 / 15 / 18																																				
IBNT	8.5 / 10 / 11.5 / 13 / 15 / 18																																				
IBNT12d-	8.5 / 10 / 11.5 / 13 / 15 / 18																																				
MSc-IBNT12d-	8.5 / 10 / 11.5 / 13 / 15 / 18																																				
CODE	LENGTHS																																				
IBR12d-	8.5 / 10 / 11.5 / 13 / 15 / 18																																				
MSc-IBR12d-	8.5 / 10 / 11.5 / 13 / 15 / 18																																				
IBR24d-	8.5 / 10 / 11.5 / 13 / 15 / 18 / 20 / 22 / 24																																				
MSc-IBR24d-	8.5 / 10 / 11.5 / 13 / 15 / 18 / 20 / 22 / 24																																				
CODE	LENGTHS																																				
IV-EX35-45	10 / 11.5 / 13 / 15																																				
IV-EX3512D-45	11.5 / 13 / 15																																				
CODE	LENGTHS																																				
IV-EX40-50	10 / 11.5 / 13 / 15																																				
IV-EX4012D-50	11.5 / 13 / 15																																				

Indirect

Compact Conical Abutment



1 / 2 / 3 / 4 / 5.5

OR



TSUZ9 **GSUZ9**
Packed with Titanium Screw
Optional Gold Screw available

SFT-MC-48



LAD-MC



PASSIVE Abutment (Compact Conical)



PA-MC-48

Non-Engaging

Main Selection
SI PASSIVE COMPACT CONICAL

Secondary Selection
PA-MC-48 NE

1 Series Screws

Implants



CODE	LENGTHS
IBN	8.5 / 10 / 11.5 / 13 / 15 / 18
IBNT	8.5 / 10 / 11.5 / 13 / 15 / 18
IBNT12d-	8.5 / 10 / 11.5 / 13 / 15 / 18
MSc-IBNT12d-	8.5 / 10 / 11.5 / 13 / 15 / 18

CODE	LENGTHS
IBR12d-	8.5 / 10 / 11.5 / 13 / 15 / 18
MSc-IBR12d-	8.5 / 10 / 11.5 / 13 / 15 / 18
IBR24d-	8.5 / 10 / 11.5 / 13 / 15 / 18 / 20 / 22 / 24
MSc-IBR24d-	8.5 / 10 / 11.5 / 13 / 15 / 18 / 20 / 22 / 24

INVERTA®

CODE	LENGTHS
IV-EX35-45	10 / 11.5 / 13 / 15
IV-EX3512D-45	11.5 / 13 / 15

CODE	LENGTHS
IV-EX40-50	10 / 11.5 / 13 / 15
IV-EX4012D-50	11.5 / 13 / 15

TIB Abutment

TIB-EX-34
TIB-EX-34-C1.5
TIB-EX-34-C3

TIB-NX-34
TIB-NX-34-C1.5
TIB-NX-34-C3



Engaging
 Engaging
 Engaging

 Non-Engaging
 Non-Engaging
 Non-Engaging

3rd Party Scanbody





Software Selection

BO 3.4L

Retaining Screws



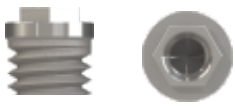

3-Series Screws

Direct

Implants	Scanning Flag	Digital Analogues	Prosthetic Components	Software Selection	Retaining Screws																												
 <table border="1"> <thead> <tr> <th>CODE</th> <th>LENGTHS</th> </tr> </thead> <tr> <td>IBS</td> <td>7 / 8.5 / 10 / 11.5 / 13 / 15 / 18 / 20</td> </tr> <tr> <td>IBT</td> <td>6 / 8.5 / 10 / 11.5 / 13 / 15</td> </tr> <tr> <td>IBPS-</td> <td>8.5 / 10 / 11.5 / 13 / 15</td> </tr> <tr> <td>IBT12d-</td> <td>8.5 / 10 / 11.5 / 13 / 15 / 18</td> </tr> <tr> <td>MSc-IBT12d-</td> <td>8.5 / 10 / 11.5 / 13 / 15 / 18</td> </tr> <tr> <td>BAR12d-</td> <td>8.5 / 10 / 11.5 / 13 / 15 / 18</td> </tr> <tr> <td>MSc-BAR12d-</td> <td>8.5 / 10 / 11.5 / 13 / 15 / 18</td> </tr> <tr> <td>BAR24d-</td> <td>8.5 / 10 / 11.5 / 13 / 15 / 18</td> </tr> <tr> <td>MSc-BAR24d-</td> <td>8.5 / 10 / 11.5 / 13 / 15 / 18</td> </tr> <tr> <td>BAR36d-</td> <td>8.5 / 10 / 11.5 / 13 / 15 / 18</td> </tr> <tr> <td>MSc-BAR36d-</td> <td>8.5 / 10 / 11.5 / 13 / 15 / 18</td> </tr> <tr> <td>MAX-6-</td> <td>6 / 7 / 9 / 11</td> </tr> <tr> <td>MSc-MAX-6-</td> <td>6 / 7 / 9 / 11</td> </tr> </table>	CODE	LENGTHS	IBS	7 / 8.5 / 10 / 11.5 / 13 / 15 / 18 / 20	IBT	6 / 8.5 / 10 / 11.5 / 13 / 15	IBPS-	8.5 / 10 / 11.5 / 13 / 15	IBT12d-	8.5 / 10 / 11.5 / 13 / 15 / 18	MSc-IBT12d-	8.5 / 10 / 11.5 / 13 / 15 / 18	BAR12d-	8.5 / 10 / 11.5 / 13 / 15 / 18	MSc-BAR12d-	8.5 / 10 / 11.5 / 13 / 15 / 18	BAR24d-	8.5 / 10 / 11.5 / 13 / 15 / 18	MSc-BAR24d-	8.5 / 10 / 11.5 / 13 / 15 / 18	BAR36d-	8.5 / 10 / 11.5 / 13 / 15 / 18	MSc-BAR36d-	8.5 / 10 / 11.5 / 13 / 15 / 18	MAX-6-	6 / 7 / 9 / 11	MSc-MAX-6-	6 / 7 / 9 / 11	 <p>SFT-EX-40</p>	 <p>LAD-IB</p>	<p>TIB Abutments</p> <p>TIB-EX-40 TIB-EX-40-C1.5 TIB-EX-40-C3</p> <p>Engaging Engaging Engaging</p> <p>TIB-NX-40 TIB-NX-40-C1.5 TIB-NX-40-C3</p> <p>Non-Engaging Non-Engaging Non-Engaging</p> <p>CIA Abutments</p> <p>CIA-EX-40 CIA-NX-40</p> <p>Engaging Non-Engaging</p> <p>PASSIVE Abutment</p> <p>SB16 SB-17-TT</p> <p>Engaging Non-Engaging</p>	<p>Main Selection SI TIB EXT-HEX</p> <p>Secondary Selection TIB-EX-40 EN TIB-EX-40-C1.5 EN TIB-EX-40-C3 EN</p> <p>TIB-NX-40 NE TIB-NX-40-C1.5 NE TIB-NX-40-C3 NE</p> <p>Main Selection SI CIA EXT-HEX</p> <p>Secondary Selection CIA-EX-40 EN CIA-NX-40 NE</p> <p>Main Selection SI PASSIVE EXT-HEX</p> <p>Secondary Selection SB16 EN SB-17-TT NE</p>	<p>3 Series Screws</p> <p>2 Series Screws</p>
CODE	LENGTHS																																
IBS	7 / 8.5 / 10 / 11.5 / 13 / 15 / 18 / 20																																
IBT	6 / 8.5 / 10 / 11.5 / 13 / 15																																
IBPS-	8.5 / 10 / 11.5 / 13 / 15																																
IBT12d-	8.5 / 10 / 11.5 / 13 / 15 / 18																																
MSc-IBT12d-	8.5 / 10 / 11.5 / 13 / 15 / 18																																
BAR12d-	8.5 / 10 / 11.5 / 13 / 15 / 18																																
MSc-BAR12d-	8.5 / 10 / 11.5 / 13 / 15 / 18																																
BAR24d-	8.5 / 10 / 11.5 / 13 / 15 / 18																																
MSc-BAR24d-	8.5 / 10 / 11.5 / 13 / 15 / 18																																
BAR36d-	8.5 / 10 / 11.5 / 13 / 15 / 18																																
MSc-BAR36d-	8.5 / 10 / 11.5 / 13 / 15 / 18																																
MAX-6-	6 / 7 / 9 / 11																																
MSc-MAX-6-	6 / 7 / 9 / 11																																

Indirect

Compact Conical Abutment

 <p>AMCZ</p> <p>1 / 2 / 3 / 4 / 5.5</p> <p>OR</p> <p>AMC17d-3 or AMC30d-4</p>   <p>TSUZ9 GSUZ9 Packed with Titanium Screw Optional Gold Screw available</p>	 <p>SFT-MC-48</p>	 <p>LAD-MC</p>	<p>PASSIVE Abutment (Compact Conical)</p> <p>PA-MC-48</p> <p>Non-Engaging</p>	<p>Main Selection SI PASSIVE COMPACT CONICAL</p> <p>Secondary Selection PA-MC-48 NE</p>	<p>1 Series Screws</p>
--	--	---	--	---	----------------------------

Implants



CODE	LENGTHS
IBS	7 / 8.5 / 10 / 11.5 / 13 / 15 / 18 / 20
IBT	6 / 8.5 / 10 / 11.5 / 13 / 15
IBPS-	8.5 / 10 / 11.5 / 13 / 15
IBT12d-	8.5 / 10 / 11.5 / 13 / 15 / 18
MSc-IBT12d-	8.5 / 10 / 11.5 / 13 / 15 / 18
BAR12d-	8.5 / 10 / 11.5 / 13 / 15 / 18
MSc-BAR12d-	8.5 / 10 / 11.5 / 13 / 15 / 18
BAR24d-	8.5 / 10 / 11.5 / 13 / 15 / 18
MSc-BAR24d-	8.5 / 10 / 11.5 / 13 / 15 / 18
BAR36d-	8.5 / 10 / 11.5 / 13 / 15 / 18
MSc-BAR36d-	8.5 / 10 / 11.5 / 13 / 15 / 18
MAX-6-	6 / 7 / 9 / 11
MSc-MAX-6-	6 / 7 / 9 / 11

TIB Abutment

TIB-EX-40
TIB-EX-40-C1.5
TIB-EX-40-C3
TIB-NX-40
TIB-NX-40-C1.5
TIB-NX-40-C3



Engaging
 Engaging
 Engaging
 Non-Engaging
 Non-Engaging
 Non-Engaging

3rd Party Scanbody



Software Selection

BO 4.1L

Retaining Screws

3-Series Screws

Direct

Implants



CODE	LENGTHS
BA	6 / 7 / 8.5 / 10 / 11.5 / 13 / 15 / 18
BAT	6 / 8.5 / 10 / 11.5 / 13 / 15 / 18
MSc-BAT	6 / 8.5 / 10 / 11.5 / 13 / 15 / 18
BAT12d-	8.5 / 10 / 11.5 / 13 / 15 / 18
MSc-BAT12d-	8.5 / 10 / 11.5 / 13 / 15 / 18
MAX-7-	7 / 9 / 11
MSc-MAX-7-	7 / 9 / 11

Scanning Flag

SFT-EX-50



Digital Analogues

LAD-BA



Prosthetic Components

TIB Abutments



TIB-EX-50
TIB-EX-50-C1.5
TIB-EX-50-C3

TIB-NX-50
TIB-NX-50-C1.5
TIB-NX-50-C3

Engaging
Engaging
Engaging

Non-Engaging
Non-Engaging
Non-Engaging

CIA Abutments



CIA-EX-50
CIA-NX-50

Engaging
Non-Engaging

PASSIVE Abutment



SBA16
SBA-17-TT

Engaging
Non-Engaging

Software Selection

Main Selection
SI TIB EXT-HEX

Secondary Selection
TIB-EX-50 EN
TIB-EX-50-C1.5 EN
TIB-EX-50-C3 EN

TIB-NX-50 NE
TIB-NX-50-C1.5 NE
TIB-NX-50-C3 NE

Main Selection
SI CIA EXT-HEX

Secondary Selection
CIA-EX-50 EN
CIA-NX-50 NE

Main Selection
SI PASSIVE EXT-HEX

Secondary Selection
SBA16 EN
SBA-17-TT NE

Retaining Screws

3 Series
Screws

2 Series
Screws

Indirect

Compact Conical Abutment

ABAMCZ



1 / 2 / 3 / 4 / 5.5

OR

ABAMC17d-3
or ABAMC30d-4



TSUZ9 GSUZ9
Packed with Titanium Screw
Optional Gold Screw available

SFT-MC-60

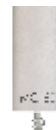

LAD-MCW



SFT-MC-48



LAD-MC



PASSIVE Abutment
(Compact Conical)



PA-MC-60



PA-MC-48

Non-Engaging

Main Selection
SI PASSIVE
COMPACT CONICAL

Secondary Selection
PA-MC-60 NE

Secondary Selection
PA-MC-48 NE

1 Series
Screws

Implants



CODE	LENGTHS
BA	6 / 7 / 8.5 / 10 / 11.5 / 13 / 15 / 18
BAT	6 / 8.5 / 10 / 11.5 / 13 / 15 / 18
MSc-BAT	6 / 8.5 / 10 / 11.5 / 13 / 15 / 18
BAT12d-	8.5 / 10 / 11.5 / 13 / 15 / 18
MSc-BAT12d-	8.5 / 10 / 11.5 / 13 / 15 / 18
MAX-7-	7 / 9 / 11
MSc-MAX-7-	7 / 9 / 11

TIB Abutment

TIB-EX-50
TIB-EX-50-C1.5
TIB-EX-50-C3
TIB-NX-50
TIB-NX-50-C1.5
TIB-NX-50-C3



Engaging
 Engaging
 Engaging
 Non-Engaging
 Non-Engaging
 Non-Engaging

3rd Party Scanbody





Software Selection

BO 5.0L

Retaining Screws



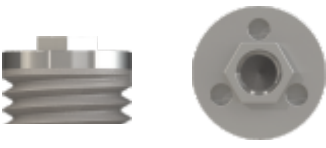

3-Series Screws

Direct

Implants	Scanning Flag	Digital Analogues	Prosthetic Components	Software Selection	Retaining Screws														
 <table border="1"> <thead> <tr> <th>CODE</th> <th>LENGTHS</th> </tr> </thead> <tbody> <tr> <td>BBBS</td> <td>7 / 8.5 / 10 / 11.5 / 13 / 15</td> </tr> <tr> <td>BBBT</td> <td>6 / 8.5 / 10 / 11.5 / 13 / 15 / 18</td> </tr> <tr> <td>BBBT12d-</td> <td>10 / 11.5 / 13 / 15 / 18</td> </tr> <tr> <td>BBBT24d-</td> <td>10 / 11.5 / 13 / 15</td> </tr> <tr> <td>MAX-8™-</td> <td>7 / 9 / 11</td> </tr> <tr> <td>MSc-MAX-8™-</td> <td>7 / 9 / 11</td> </tr> </tbody> </table>	CODE	LENGTHS	BBBS	7 / 8.5 / 10 / 11.5 / 13 / 15	BBBT	6 / 8.5 / 10 / 11.5 / 13 / 15 / 18	BBBT12d-	10 / 11.5 / 13 / 15 / 18	BBBT24d-	10 / 11.5 / 13 / 15	MAX-8™-	7 / 9 / 11	MSc-MAX-8™-	7 / 9 / 11	 <p>SFT-EX-60</p>	 <p>LAD-BBB</p>	<p>TIB Abutments</p> <p>TIB-EX-60 TIB-EX-60-C1.5 TIB-EX-60-C3</p> <p>Engaging Engaging Engaging</p> <p>TIB-NX-60 TIB-NX-60-C1.5 TIB-NX-60-C3</p> <p>Non-Engaging Non-Engaging Non-Engaging</p> <p>CIA Abutments</p> <p>CIA-EX-60 CIA-NX-60</p> <p>Engaging Non-Engaging</p> <p>PASSIVE Abutment</p> <p>SBBB16 SBBB-17-TT</p> <p>Engaging Non-Engaging</p>	<p>Main Selection SI TIB EXT-HEX</p> <p>Secondary Selection TIB-EX-60 EN TIB-EX-60-C1.5 EN TIB-EX-60-C3 EN</p> <p>TIB-NX-60 NE TIB-NX-60-C1.5 NE TIB-NX-60-C3 NE</p> <p>Main Selection SI CIA EXT-HEX</p> <p>Secondary Selection CIA-EX-60 EN CIA-NX-60 NE</p> <p>Main Selection SI PASSIVE EXT-HEX</p> <p>Secondary Selection SBBB16 EN SBBB-17-TT NE</p>	<p>3 Series Screws</p> <p>2 Series Screws</p>
CODE	LENGTHS																		
BBBS	7 / 8.5 / 10 / 11.5 / 13 / 15																		
BBBT	6 / 8.5 / 10 / 11.5 / 13 / 15 / 18																		
BBBT12d-	10 / 11.5 / 13 / 15 / 18																		
BBBT24d-	10 / 11.5 / 13 / 15																		
MAX-8™-	7 / 9 / 11																		
MSc-MAX-8™-	7 / 9 / 11																		

Indirect

Compact Conical Abutment

<p>ABBMCZ</p>  <p>1 / 2 / 3 OR</p> <p>ABBMC17d-3 or ABBMC30d-4</p>  <p>TSUZ9 GSUZ9 Packed with Titanium Screw Optional Gold Screw available</p>	 <p>SFT-MC-60</p>	 <p>LAD-MCW</p>	<p>PASSIVE Abutment (Compact Conical)</p> <p>PA-MC-60</p>	<p>Main Selection SI PASSIVE COMPACT CONICAL</p> <p>Secondary Selection PA-MC-60 NE</p>	<p>1 Series Screws</p>
---	--	--	--	---	----------------------------

Implants



CODE	LENGTHS
BBBS	7 / 8.5 / 10 / 11.5 / 13 / 15
BBBT	6 / 8.5 / 10 / 11.5 / 13 / 15 / 18
BBBT12d-	10 / 11.5 / 13 / 15 / 18
BBBT24d-	10 / 11.5 / 13 / 15
MAX-8™-	7 / 9 / 11
MSc-MAX-8™-	7 / 9 / 11

TIB Abutment

TIB-EX-60
TIB-EX-60-C1.5
TIB-EX-60-C3
TIB-NX-60
TIB-NX-60-C1.5
TIB-NX-60-C3



Engaging
 Engaging
 Engaging
 Non-Engaging
 Non-Engaging
 Non-Engaging

3rd Party Scanbody





Software Selection

NB RS 6.0L

Retaining Screws

3-Series Screws

Direct

Implants	Scanning Flag	Digital Analogues	Prosthetic Components	Software Selection	Retaining Screws										
 <p>8.5 / 10 / 11.5 / 13 / 15 / 18</p> <table border="1"> <thead> <tr> <th>CODE</th> <th>LENGTHS</th> </tr> </thead> <tbody> <tr> <td>IM-T37</td> <td>08 / 10 / 11 / 13 / 15</td> </tr> <tr> <td>IM-T42</td> <td>08 / 10 / 11 / 13 / 15</td> </tr> <tr> <td>IM-T50</td> <td>08 / 10 / 11 / 13 / 15</td> </tr> <tr> <td>IM-T42xx-12d</td> <td>08 / 10 / 11 / 13 / 15</td> </tr> </tbody> </table>	CODE	LENGTHS	IM-T37	08 / 10 / 11 / 13 / 15	IM-T42	08 / 10 / 11 / 13 / 15	IM-T50	08 / 10 / 11 / 13 / 15	IM-T42xx-12d	08 / 10 / 11 / 13 / 15	 <p>SFT-M</p>	 <p>LAD-M</p>	<p>TIB Abutments</p> <p>TIB-M TIB-M-C1.5 TIB-M-C3</p> <p>Engaging Engaging Engaging</p> <p>TIB-NM TIB-NM-C1.5 TIB-NM-C3</p> <p>Non-Engaging Non-Engaging Non-Engaging</p> <p>CAB Abutments</p> <p>CAB-M CAB-NM</p> <p>Engaging Non-Engaging</p> <p>CIA Abutments</p> <p>CIA-EM CIA-NM</p> <p>Engaging Non-Engaging</p> <p>PASSIVE Abutment</p> <p>PA-EM-S PA-NM-S</p> <p>Engaging Non-Engaging</p>	<p>Main Selection SI TIB INT-HEX</p> <p>Secondary Selection TIB-M EN TIB-M-C1.5 EN TIB-M-C3 EN</p> <p>TIB-NM NE TIB-NM-C1.5 NE TIB-NM-C3 NE</p> <p>Main Selection SI CAB INT-HEX</p> <p>Secondary Selection CAB-M EN CAB-NM NE</p> <p>Main Selection SI CIA INT-HEX</p> <p>Secondary Selection CIA-EM EN CIA-NM NE</p> <p>Main Selection SI PASSIVE INT-HEX</p> <p>Secondary Selection PA-EM-S EN PA-NM-S NE</p>	<p>TS-Z-18</p>  <p>Titanium (1.27 Hex)</p> <p>GS-Q-18</p>  <p>Gold (Quad)</p> <p>BS-Z-18 *</p>  <p>Brass (1.27 Hex) <i>*(Blackened. For laboratory use only)</i></p> <p>PA-M-18T</p>  <p>Titanium</p> <p>PA-Q-18G</p>  <p>Gold</p> <p>PA-M-18B</p>  <p>Brass*</p>
CODE	LENGTHS														
IM-T37	08 / 10 / 11 / 13 / 15														
IM-T42	08 / 10 / 11 / 13 / 15														
IM-T50	08 / 10 / 11 / 13 / 15														
IM-T42xx-12d	08 / 10 / 11 / 13 / 15														

Indirect

Compact Conical Abutment



SFT-MC-48



LAD-MC



PASSIVE Abutment (Compact Conical)

PA-MC-48

Non-Engaging



Main Selection
SI PASSIVE COMPACT CONICAL

Secondary Selection
PA-MC-48 NE

1 Series Screws

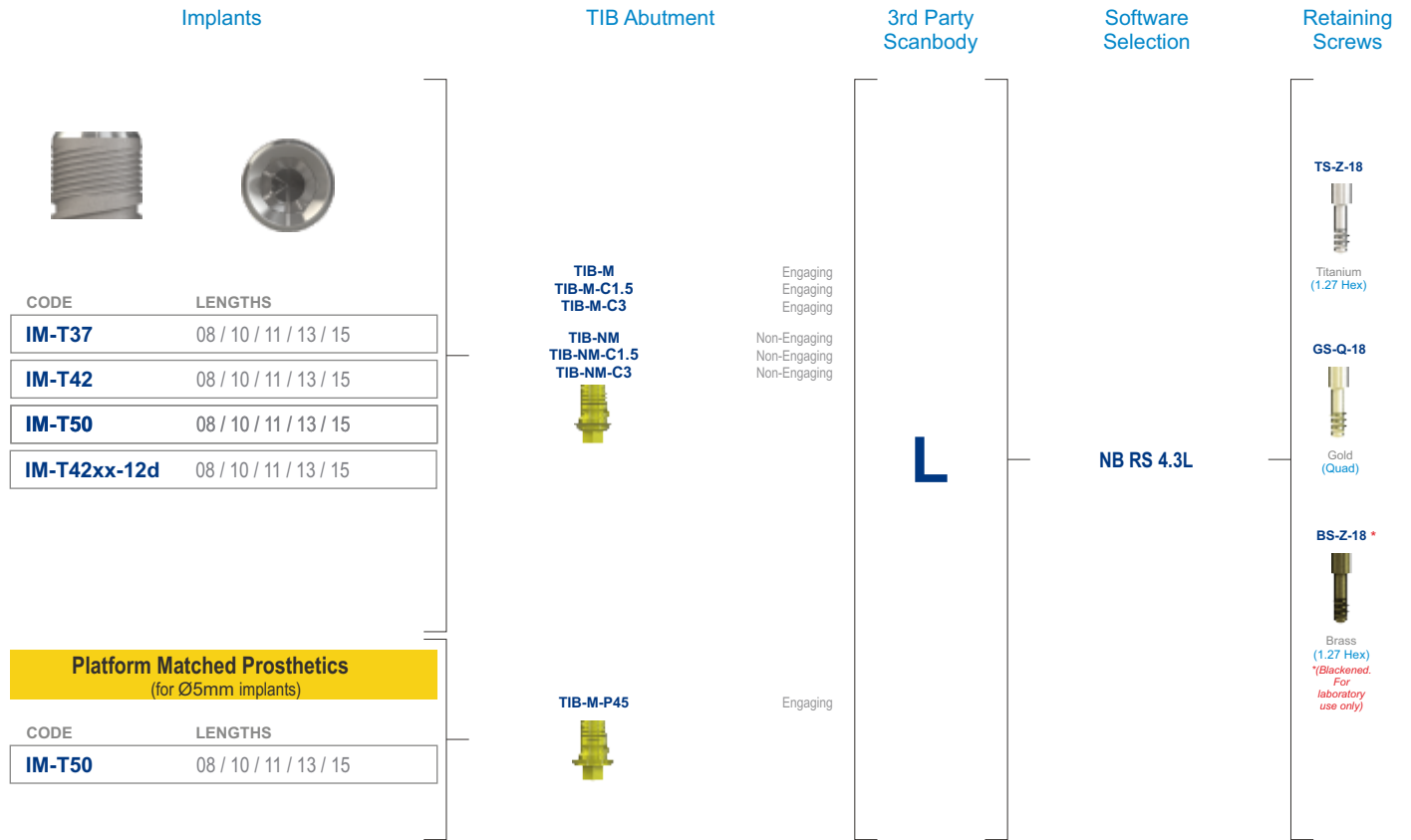

Direct

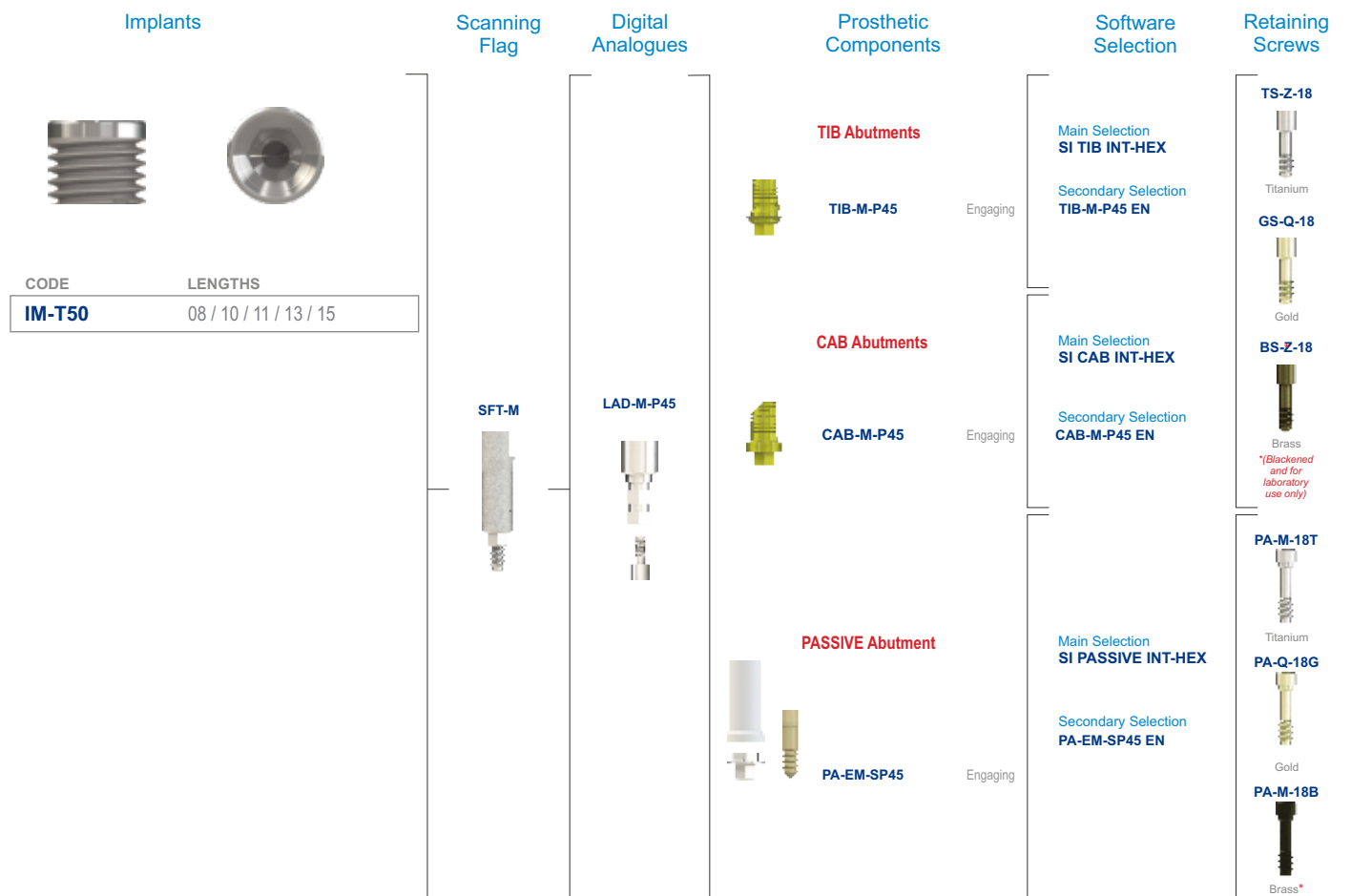

Direct

Implants



CODE	LENGTHS
PRO4	08 / 10 / 11 / 13 / 15 / 18
MSC-PRO4	08 / 10 / 11 / 13 / 15 / 18
PRO5	08 / 10 / 11 / 13 / 15 / 18
MSC-PRO5	08 / 10 / 11 / 13 / 15 / 18
PRO12D4	08 / 10 / 11 / 13 / 15 / 18
MSC-PRO12D4	08 / 10 / 11 / 13 / 15 / 18
PRO12D5	08 / 10 / 11 / 13 / 15 / 18
MSC-PRO12D5	08 / 10 / 11 / 13 / 15 / 18
PROMAX6	07 / 09 / 11

Scanning Flag

SFT-M



Digital Analogues

LAD-M



Prosthetic Components

TIB Abutments



TIB-M
TIB-M-C1.5
TIB-M-C3

TIB-NM
TIB-NM-C1.5
TIB-NM-C3

Engaging
Engaging
Engaging

Non-Engaging
Non-Engaging
Non-Engaging

CAB Abutments



CAB-M
CAB-NM

Engaging
Non-Engaging

CIA Abutments



CIA-EM
CIA-NM

Engaging
Non-Engaging

PASSIVE Abutment



PA-EM-S
PA-NM-S

Engaging
Non-Engaging

Software Selection

Main Selection
SI TIB INT-HEX

Secondary Selection
TIB-M EN
TIB-M-C1.5 EN
TIB-M-C3 EN

TIB-NM NE
TIB-NM-C1.5 NE
TIB-NM-C3 NE

Main Selection
SI CAB INT-HEX

Secondary Selection
CAB-M EN
CAB-NM NE

Main Selection
SI CIA INT-HEX

Secondary Selection
CIA-EM EN
CIA-NM NE

Main Selection
SI PASSIVE INT-HEX

Secondary Selection
PA-EM-S EN
PA-NM-S NE

Retaining Screws

TS-Z-18



Titanium
(1.27 Hex)

GS-Q-18



Gold
(Quad)

BS-Z-18 *



Brass
(1.27 Hex)
**(Blackened. For laboratory use only)*

PA-M-18T



Titanium

PA-Q-18G



Gold

PA-M-18B



Brass*

Indirect

Compact Conical Abutment

MC-M



1 / 3

MC-M-20d



MC-M-30d



SFT-MC-48



LAD-MC



PASSIVE Abutment
(Compact Conical)





PA-MC-48

Non-Engaging



Main Selection
SI PASSIVE
COMPACT CONICAL

Secondary Selection
PA-MC-48 NE

1 Series
Screws

Implants		TIB Abutment	3rd Party Scanbody	Software Selection	Retaining Screws	
						
CODE	LENGTHS					
PRO4	08 / 10 / 11 / 13 / 15 / 18	TIB-M TIB-M-C1.5 TIB-M-C3		NB RS 4.3L	TS-Z-18 Titanium (1.27 Hex)	
MSC-PRO4	08 / 10 / 11 / 13 / 15 / 18	TIB-NM TIB-NM-C1.5 TIB-NM-C3			Engaging Engaging Engaging	GS-Q-18 Gold (Quad)
PRO5	08 / 10 / 11 / 13 / 15 / 18				Non-Engaging Non-Engaging Non-Engaging	BS-Z-18 * Brass (1.27 Hex) <i>*(Blackened. For laboratory use only)</i>
MSC-PRO5	08 / 10 / 11 / 13 / 15 / 18				Engaging	
PRO12D4	08 / 10 / 11 / 13 / 15 / 18					
MSC-PRO12D4	08 / 10 / 11 / 13 / 15 / 18					
PRO12D5	08 / 10 / 11 / 13 / 15 / 18					
MSC-PRO12D5	08 / 10 / 11 / 13 / 15 / 18					
PROMAX6	07 / 09 / 11					
Platform Matched Prosthetics (for Ø5mm and Ø6mm implants)						
CODE	LENGTHS					
PRO5	08 / 10 / 11 / 13 / 15 / 18					
PROMAX6	07 / 09 / 11					

Direct

Implants	Scanning Flag	Digital Analogues	Prosthetic Components	Software Selection	Retaining Screws
					
CODE	LENGTHS				
PRO5	08 / 10 / 11 / 13 / 15 / 18	SFT-M 	TIB Abutments	Main Selection SI TIB INT-HEX	TS-Z-18 Titanium
MSC-PRO5	08 / 10 / 11 / 13 / 15 / 18		LAD-M-P45 		TIB-M-P45 Engaging
PROMAX6	07 / 09 / 11		CAB Abutments	Main Selection SI CAB INT-HEX	BS-Z-18 Brass <i>*(Blackened and for laboratory use only)</i>
			CAB-M-P45 Engaging		Secondary Selection CAB-M-P45 EN
			PASSIVE Abutment	Main Selection SI PASSIVE INT-HEX	PA-M-18T Titanium
			PA-EM-SP45 Engaging		Secondary Selection PA-EM-SP45 EN
					PA-M-18B Brass*

Direct

Implants

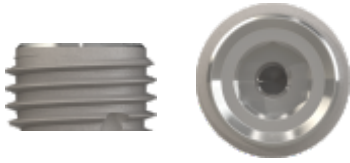

CODE	LENGTHS
PROMAX7	07 / 09 / 11
PROMAX8	07 / 09 / 11
PROMAX9	07 / 09 / 11

Scanning Flag



Digital Analogues



Prosthetic Components

TIB Abutments



- TIB-Z
TIB-Z-C1.5
TIB-Z-C3
 - TIB-NZ
TIB-NZ-C1.5
TIB-NZ-C3
- Engaging
Engaging
Engaging
- Non-Engaging
Non-Engaging
Non-Engaging

CAB Abutments



- CAB-Z
- Engaging

CIA Abutments



- CIA-EZ
CIA-NZ
- Engaging
Non-Engaging

PASSIVE Abutment



- PA-EZ
PA-NZ
- Engaging
Non-Engaging

Software Selection

Main Selection
SI TIB INT-HEX

Secondary Selection
TIB-Z EN
TIB-Z-C1.5 EN
TIB-Z-C3 EN

TIB-NZ NE
TIB-NZ-C1.5 NE
TIB-NZ-C3 NE

Main Selection
SI CAB INT-HEX

Secondary Selection
CAB-Z EN

Main Selection
SI CIA INT-HEX

Secondary Selection
CIA-EZ EN
CIA-NZ NE

Main Selection
SI PASSIVE INT-HEX

Secondary Selection
PA-EZ EN
PA-NZ NE

Retaining Screws



Brass*

Indirect

Compact Conical Abutment



1 / 3 / 5



PASSIVE Abutment
(Compact Conical)



PA-MC-60

Main Selection
SI PASSIVE
COMPACT CONICAL

Secondary Selection
PA-MC-60 NE

1 Series
Screws

Implants

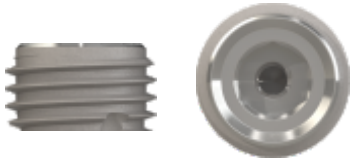

CODE	LENGTHS
PROMAX7	07 / 09 / 11
PROMAX8	07 / 09 / 11
PROMAX9	07 / 09 / 11

TIB Abutment

TIB-Z
TIB-Z-C1.5
TIB-Z-C3
TIB-NZ
TIB-NZ-C1.5
TIB-NZ-C3



Engaging
 Engaging
 Engaging
 Non-Engaging
 Non-Engaging
 Non-Engaging

3rd Party Scanbody



Software Selection

B0 5.0L

Retaining Screws

TS-Z-18



Titanium
 (1.27 Hex)

GS-Q-18











Gold
 (Quad)

BS-Z-18 *









Brass
 (1.27 Hex)
 *(Blackened.
 For
 laboratory
 use only)

Direct

Implants	Scanning Flag	Digital Analogues	Prosthetic Components	Software Selection	Retaining Screws										
 <table border="1"> <thead> <tr> <th>CODE</th> <th>LENGTHS</th> </tr> </thead> <tbody> <tr> <td>DCT30</td> <td>9 / 11 / 13</td> </tr> <tr> <td>DCC30</td> <td>11 / 13 / 15</td> </tr> <tr> <td>DCT35xx-12d</td> <td>08 / 09 / 10 / 11 / 13 / 15</td> </tr> <tr> <td>DCC35xx-12d</td> <td>08 / 09 / 10 / 11 / 13 / 15</td> </tr> </tbody> </table>	CODE	LENGTHS	DCT30	9 / 11 / 13	DCC30	11 / 13 / 15	DCT35xx-12d	08 / 09 / 10 / 11 / 13 / 15	DCC35xx-12d	08 / 09 / 10 / 11 / 13 / 15	 <p>SFT-DC3</p>	 <p>LAD-DC3</p>	<p>CAB Abutments</p>  <p>CAB-DC3 Engaging</p> <p>PASSIVE Abutment</p>  <p>PA-DC3 Engaging PA-NDC3 Non-Engaging</p>	<p>Main Selection SI CAB DC</p> <p>Secondary Selection CAB-DC3 EN</p> <p>Main Selection SI PASSIVE DC</p> <p>Secondary Selection PA-DC3 EN PA-NDC3 NE</p>	<p>TS-DC3-14</p>  <p>Titanium</p> <p>BS-DC3-14*</p>  <p>Brass <i>*(Blackened and for laboratory use only)</i></p> <p>PA-DC3-14T</p>  <p>Titanium</p> <p>PA-DC3-14B*</p>  <p>Brass <i>(anodized yellow) (for laboratory use only)</i></p>
CODE	LENGTHS														
DCT30	9 / 11 / 13														
DCC30	11 / 13 / 15														
DCT35xx-12d	08 / 09 / 10 / 11 / 13 / 15														
DCC35xx-12d	08 / 09 / 10 / 11 / 13 / 15														











Indirect

Compact Conical Abutment

<p>MC-DC3</p>  <p>1 / 3 / 4 / 5</p> <p>MC-DC3-20d</p>  <p>MC-DC3-30d</p> 	<p>SFT-MC-48</p> 	<p>LAD-MC</p> 	<p>PASSIVE Abutment (Compact Conical)</p>  <p>PA-MC-48 Non-Engaging</p>	<p>Main Selection SI PASSIVE COMPACT CONICAL</p> <p>Secondary Selection PA-MC-48 NE</p>	<p>1 Series Screws</p>
---	---	--	--	---	-------------------------------







Not available

Direct

Implants	Scanning Flag	Digital Analogues	Prosthetic Components	Software Selection	Retaining Screws																														
 <table border="1"> <thead> <tr> <th>CODE</th> <th>LENGTHS</th> </tr> </thead> <tbody> <tr> <td>DCT35</td> <td>08 / 09 / 11 / 13 / 15</td> </tr> <tr> <td>DCC35</td> <td>08 / 09 / 11 / 13 / 15</td> </tr> <tr> <td>DCT40</td> <td>06 / 08 / 09 / 11 / 13 / 15</td> </tr> <tr> <td>DCC40</td> <td>06 / 08 / 09 / 11 / 13 / 15</td> </tr> <tr> <td>DCT40xx-12d</td> <td>08 / 09 / 10 / 11 / 13 / 15</td> </tr> <tr> <td>DCC40xx-12d</td> <td>08 / 09 / 10 / 11 / 13 / 15</td> </tr> <tr> <td>DCT50xx-12d</td> <td>08 / 09 / 10 / 11 / 13 / 15</td> </tr> <tr> <td>DCC50xx-12d</td> <td>08 / 09 / 10 / 11 / 13 / 15</td> </tr> </tbody> </table> <p>INVERTA®</p> <table border="1"> <thead> <tr> <th>CODE</th> <th>LENGTHS</th> </tr> </thead> <tbody> <tr> <td>IV-DC35-45</td> <td>10 / 11.5 / 13 / 15</td> </tr> <tr> <td>IV-DC3512D-45</td> <td>11 / 13 / 15</td> </tr> </tbody> </table> <table border="1"> <thead> <tr> <th>CODE</th> <th>LENGTHS</th> </tr> </thead> <tbody> <tr> <td>IV-DC40-50</td> <td>10 / 11.5 / 13 / 15</td> </tr> <tr> <td>IV-DC4012D-50</td> <td>11 / 13 / 15</td> </tr> </tbody> </table>	CODE	LENGTHS	DCT35	08 / 09 / 11 / 13 / 15	DCC35	08 / 09 / 11 / 13 / 15	DCT40	06 / 08 / 09 / 11 / 13 / 15	DCC40	06 / 08 / 09 / 11 / 13 / 15	DCT40xx-12d	08 / 09 / 10 / 11 / 13 / 15	DCC40xx-12d	08 / 09 / 10 / 11 / 13 / 15	DCT50xx-12d	08 / 09 / 10 / 11 / 13 / 15	DCC50xx-12d	08 / 09 / 10 / 11 / 13 / 15	CODE	LENGTHS	IV-DC35-45	10 / 11.5 / 13 / 15	IV-DC3512D-45	11 / 13 / 15	CODE	LENGTHS	IV-DC40-50	10 / 11.5 / 13 / 15	IV-DC4012D-50	11 / 13 / 15	<p>SFT-DC4</p> 	<p>LAD-DC4</p> 	<p>TIB Abutments</p>  <p>TIB-DC4 TIB-DC4-C1.5 TIB-DC4-C3</p> <p>Engaging Engaging Engaging</p> <p>TIB-NDC4 TIB-NDC4-C1.5 TIB-NDC4-C3</p> <p>Non-Engaging Non-Engaging Non-Engaging</p> <p>CAB Abutments</p>  <p>CAB-DC4</p> <p>Engaging</p> <p>PASSIVE Abutment</p>  <p>PA-DC4 PA-NDC4</p> <p>Engaging Non-Engaging</p>	<p>Main Selection SI TIB DC</p> <p>Secondary Selection TIB-DC4 EN TIB-DC4-C1.5 EN TIB-DC4-C3 EN</p> <p>TIB-NDC4 NE TIB-NDC4-C1.5 NE TIB-NDC4-C3 NE</p> <p>Main Selection SI CAB DC</p> <p>Secondary Selection CAB-DC4 EN</p> <p>Main Selection SI PASSIVE DC</p> <p>Secondary Selection PA-DC4 EN PA-NDC4 NE</p>	<p>TS-DC4-16</p>  <p>Titanium</p> <p>BS-DC4-16*</p>  <p>Brass <i>*(Blackened and for laboratory use only)</i></p> <p>PA-DC4-16T</p>  <p>Titanium</p> <p>PA-DC4-16B*</p>  <p>Brass <i>(anodized blue) (for laboratory use only)</i></p>
CODE	LENGTHS																																		
DCT35	08 / 09 / 11 / 13 / 15																																		
DCC35	08 / 09 / 11 / 13 / 15																																		
DCT40	06 / 08 / 09 / 11 / 13 / 15																																		
DCC40	06 / 08 / 09 / 11 / 13 / 15																																		
DCT40xx-12d	08 / 09 / 10 / 11 / 13 / 15																																		
DCC40xx-12d	08 / 09 / 10 / 11 / 13 / 15																																		
DCT50xx-12d	08 / 09 / 10 / 11 / 13 / 15																																		
DCC50xx-12d	08 / 09 / 10 / 11 / 13 / 15																																		
CODE	LENGTHS																																		
IV-DC35-45	10 / 11.5 / 13 / 15																																		
IV-DC3512D-45	11 / 13 / 15																																		
CODE	LENGTHS																																		
IV-DC40-50	10 / 11.5 / 13 / 15																																		
IV-DC4012D-50	11 / 13 / 15																																		

Indirect

Compact Conical Abutment

<p>MC-DC4</p>  <p>1 / 3 / 4 / 5</p> <p>MC-DC4-20d</p>  <p>MC-DC4-30d</p> 	<p>SFT-MC-48</p> 	<p>LAD-MC</p> 	<p>PASSIVE Abutment (Compact Conical)</p>  <p>PA-MC-48</p> <p>Non-Engaging</p>	<p>Main Selection SI PASSIVE COMPACT CONICAL</p> <p>Secondary Selection PA-MC-48 NE</p>	<p>1 Series Screws</p>
---	---	--	--	---	-------------------------------

Implants



CODE	LENGTHS
DCT35	08 / 09 / 11 / 13 / 15
DCC35	08 / 09 / 11 / 13 / 15
DCT40	06 / 08 / 09 / 11 / 13 / 15
DCC40	06 / 08 / 09 / 11 / 13 / 15
DCT40xx-12d	08 / 09 / 10 / 11 / 13 / 15
DCC40xx-12d	08 / 09 / 10 / 11 / 13 / 15
DCT50xx-12d	08 / 09 / 10 / 11 / 13 / 15
DCC50xx-12d	08 / 09 / 10 / 11 / 13 / 15

INVERTA®

CODE	LENGTHS
IV-DC35-45	10 / 11.5 / 13 / 15
IV-DC3512D-45	11 / 13 / 15

CODE	LENGTHS
IV-DC40-50	10 / 11.5 / 13 / 15
IV-DC4012D-50	11 / 13 / 15

TIB Abutment

TIB-DC4
TIB-DC4-C1.5
TIB-DC4-C3

TIB-NDC4
TIB-NDC4-C1.5
TIB-NDC4-C3



Engaging
 Engaging
 Engaging

Non-Engaging
 Non-Engaging
 Non-Engaging

3rd Party Scanbody



Software Selection

AT OS 3.5/4.0L

Retaining Screws

TS-DC4-16



Titanium

BS-DC4-16*



Brass
 *Backened and for laboratory use only

Direct

Implants



CODE	LENGTHS
DCT50	09 / 11 / 13 / 15
DCC50	09 / 11 / 13 / 15

Scanning Flag

SFT-DC5
Scanning Flag

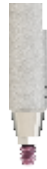

Digital Analogues

LAD-DC5



Prosthetic Components

TIB Abutments



TIB-DC5
TIB-DC5-C1.5
TIB-DC5-C3
TIB-NDC5
TIB-NDC5-C1.5
TIB-NDC5-C3

Engaging
Engaging
Engaging
Non-Engaging
Non-Engaging
Non-Engaging

CAB Abutments



CAB-DC5

Engaging

PASSIVE Abutment



PA-DC5
PA-NDC5

Engaging
Non-Engaging

Software Selection

Main Selection
SI TIB DC

Secondary Selection
TIB-DC5 EN
TIB-DC5-C1.5 EN
TIB-DC5-C3 EN

TIB-NDC5 NE
TIB-NDC5-C1.5 NE
TIB-NDC5-C3 NE

Main Selection
SI CAB DC

Secondary Selection
CAB-DC5 EN

Main Selection
SI PASSIVE DC

Secondary Selection
PA-DC5 EN
PA-NDC5 NE

Retaining Screws

TS-DC5-20



Titanium

BS-DC5-20



Brass

**Blackened and for laboratory use only*

PA-DC5-20T



Titanium

PA-DC5-20B



Brass

*(anodized purple) *for laboratory use only*

Indirect

Compact Conical Abutment

MC-DC5



1 / 3 / 4 / 5

SFT-MC-48



LAD-MC



PASSIVE Abutment (Compact Conical)



PA-MC-48

Non-Engaging

Main Selection
SI PASSIVE COMPACT CONICAL

Secondary Selection
PA-MC-48 NE

1 Series Screws

Implants



CODE	LENGTHS
DCT50	09 / 11 / 13 / 15
DCC50	09 / 11 / 13 / 15

TIB Abutment

TIB-DC5
TIB-DC5-C1.5
TIB-DC5-C3
TIB-NDC5
TIB-NDC5-C1.5
TIB-NDC5-C3



Engaging
 Engaging
 Engaging
 Non-Engaging
 Non-Engaging
 Non-Engaging

3rd Party Scanbody



Software Selection

AT OS 4.5/5.0L

Retaining Screws

TS-DC5-20



Titanium

BS-DC5-20



Brass

**Blackened and for laboratory use only*

Direct

Implants



CODE	LENGTHS
IA-LH-35-	8 / 10 / 11.5 / 13 / 16
IA-LHS-35-	8 / 10 / 11.5 / 13 / 15
IA43-12d	10 / 11.5 / 13 / 16

Scanning Flag

SFT-EL-35



Digital Analogues

LAD-L-35



Prosthetic Components

TIB Abutments



TIB-EL-35
TIB-EL-35-C1.5
TIB-EL-35-C3

Engaging
Engaging
Engaging

TIB-NL-35
TIB-NL-35-C1.5
TIB-NL-35-C3

Non-Engaging
Non-Engaging
Non-Engaging

CIA Abutments



CIA-EL-35
CIA-NL-35

Engaging
Non-Engaging

PASSIVE Abutment



PA-EL-35
PA-NL-35

Engaging
Non-Engaging

Software Selection

Main Selection
SI TIB TRI-NEX

Secondary Selection
TIB-EL-35 EN
TIB-EL-35-C1.5 EN
TIB-EL-35-C3 EN

TIB-NL-35 NE
TIB-NL-35-C1.5 NE
TIB-NL-35-C3 NE

Main Selection
SI CIA TRI-NEX

Secondary Selection
CIA-EL-35 EN
CIA-NL-35 NE

Main Selection
SI PASSIVE TRI-NEX

Secondary Selection
PA-EL-35 EN
PA-NL-35 NE

Retaining Screws

TS-L-18



Titanium

TS-L-18C



Coated

GS-L-18



Gold

BS-L-18*



Brass

* (Blackened - for laboratory use only)

PA-L-18



Titanium

PA-L-18G



Gold

PA-L-18B*



Brass

Indirect

Compact Conical Abutment

MC-L-35



1 / 2 / 3 / 4 / 5 / 7
OR

MCL-35-17d



2 / 3

SFT-MC-48



LAD-MC



PASSIVE Abutment
(Compact Conical)



PA-MC-48

Non-Engaging

Main Selection
SI PASSIVE
COMPACT CONICAL

Secondary Selection
PA-MC-48 NE

1 Series
Screws

Implants



CODE	LENGTHS
IA-LH-35-	8 / 10 / 11.5 / 13 / 16
IA-LHS-35-	8 / 10 / 11.5 / 13 / 15
IA43-12d	10 / 11.5 / 13 / 16

TIB Abutment

TIB-EL-35
TIB-EL-35-C1.5
TIB-EL-35-C3

TIB-NL-35
TIB-NL-35-C1.5
TIB-NL-35-C3



Engaging
 Engaging
 Engaging

Non-Engaging
 Non-Engaging
 Non-Engaging

3rd Party Scanbody



Software Selection

NB RS 3.5L

Retaining Screws

TS-L-18



Titanium

TS-L-18C



Coated

GS-L-18



Gold

BS-L-18



Brass

* (Blackened
 - for laboratory
 use only)

Direct

Implants



CODE	LENGTHS
IA-LH-43-	8 / 10 / 11.5 / 13 / 16
IA-LHS-43-	8 / 10 / 11.5 / 13 / 15
IA50-12d	10 / 11.5 / 13 / 16

Scanning Flag

SFT-EL-43



Digital Analogues

LAD-L-43



Prosthetic Components

TIB Abutments



TIB-EL-43
TIB-EL-43-C1.5
TIB-EL-43-C3

Engaging
Engaging
Engaging

TIB-NL-43
TIB-NL-43-C1.5
TIB-NL-43-C3

Non-Engaging
Non-Engaging
Non-Engaging

CIA Abutments



CIA-EL-43
CIA-NL-43

Engaging
Non-Engaging

PASSIVE Abutment



PA-EL-43
PA-NL-43

Engaging
Non-Engaging

Software Selection

Main Selection
SI TIB TRI-NEX

Secondary Selection
TIB-EL-43 EN
TIB-EL-43-C1.5 EN
TIB-EL-43-C3 EN

TIB-NL-43 NE
TIB-NL-43-C1.5 NE
TIB-NL-43-C3 NE

Main Selection
SI CIA TRI-NEX

Secondary Selection
CIA-EL-43 EN
CIA-NL-43 NE

Main Selection
SI PASSIVE TRI-NEX

Secondary Selection
PA-EL-43 EN
PA-NL-43 NE

Retaining Screws

TS-L-20



Titanium

TS-L-20C



Coated

GS-L-20



Gold

BS-L-20



Brass

**(Blackened
- for laboratory
use only)*

PA-L-20



Titanium

PA-L-20G



Gold

PA-L-20B



Brass

Indirect

Compact Conical Abutment

MC-L-43



1/2/3/4/5/7

OR

MCL-43-17d



2/3

MCL-43-30d



4

SFT-MC-48



LAD-MC



PASSIVE Abutment
(Compact Conical)



PA-MC-48

Non-Engaging

Main Selection
SI PASSIVE COMPACT CONICAL

Secondary Selection
PA-MC-48 NE

1 Series
Screws

Implants



CODE	LENGTHS
IA-LH-43-	8 / 10 / 11.5 / 13 / 16
IA-LHS-43-	8 / 10 / 11.5 / 13 / 15
IA50-12d	10 / 11.5 / 13 / 16

TIB Abutment

TIB-EL-43
 TIB-EL-43-C1.5
 TIB-EL-43-C3

TIB-NL-43
 TIB-NL-43-C1.5
 TIB-NL-43-C3



Engaging
 Engaging
 Engaging

Non-Engaging
 Non-Engaging
 Non-Engaging

3rd Party Scanbody



Software Selection

NB RS 4.3L

Retaining Screws

TS-L-20



Titanium

TS-L-20C



Coated

GS-L-20



Gold

BS-L-20



Brass

*(Blackened
 - for laboratory
 use only)

Direct

Implants



CODE	LENGTHS
IA-LH-50-	8 / 10 / 11.5 / 13 / 16
IA-LHS-50-	8 / 10 / 11.5 / 13 / 15
TRI-MAX7-	7 / 9 / 11

Scanning Flag



Digital Analogues



Prosthetic Components

TIB Abutments



TIB-EL-50
TIB-EL-50-C1.5
TIB-EL-50-C3

Engaging
Engaging
Engaging

TIB-NL-50
TIB-NL-50-C1.5
TIB-NL-50-C3

Non-Engaging
Non-Engaging
Non-Engaging

CIA Abutments



CIA-EL-50
CIA-NL-50

Engaging
Non-Engaging

PASSIVE Abutment



PA-EL-50
PA-NL-50

Engaging
Non-Engaging

Software Selection

Main Selection
SI TIB TRI-NEX

Secondary Selection
TIB-EL-50 EN
TIB-EL-50-C1.5 EN
TIB-EL-50-C3 EN

TIB-NL-50 NE
TIB-NL-50-C1.5 NE
TIB-NL-50-C3 NE

Main Selection
SI CIA TRI-NEX

Secondary Selection
CIA-EL-50 EN
CIA-NL-50 NE

Main Selection
SI PASSIVE TRI-NEX

Secondary Selection
PA-EL-50 EN
PA-NL-50 NE

Retaining Screws

TS-L-20



Titanium

TS-L-20C



Coated

GS-L-20



Gold

BS-L-20



Brass

*(Blackened - for laboratory use only)

PA-L-20



Titanium

PA-L-20G



Gold

PA-L-20B*



Brass

Indirect

Compact Conical Abutment

MC-L-50



1 / 2 / 3 / 5

OR

MCN-L-50



1 / 2 / 3

SFT-MC-60



LAD-MCW



SFT-MC-48



LAD-MC

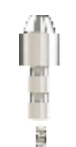

PASSIVE Abutment (Compact Conical)



PA-MC-60



PA-MC-48

Non-Engaging

Main Selection
SI PASSIVE COMPACT CONICAL

Secondary Selection
PA-MC-60 NE

Secondary Selection
PA-MC-48 NE

1 Series Screws

Implants



CODE	LENGTHS
IA-LH-50-	8 / 10 / 11.5 / 13 / 16
IA-LHS-50-	8 / 10 / 11.5 / 13 / 15
TRI-MAX7-	7 / 9 / 11

TIB Abutment

TIB-EL-50
TIB-EL-50-C1.5
TIB-EL-50-C3

TIB-NL-50
TIB-NL-50-C1.5
TIB-NL-50-C3



Engaging
 Engaging
 Engaging

Non-Engaging
 Non-Engaging
 Non-Engaging

3rd Party Scanbody



Software Selection

NB RS 5.0L

Retaining Screws

TS-L-20



Titanium

TS-L-20C



Coated

GS-L-20



Gold

BS-L-20



Brass

*(Blackened
 - for laboratory
 use only)

Direct

Implants



CODE	LENGTHS
IA-LH-60-	8 / 10 / 11.5 / 13 / 16
TRI-MAX8	7 / 9 / 11
TRI-MAX9	7 / 9 / 11

Scanning Flag



Digital Analogues



Prosthetic Components

TIB Abutments



TIB-EL-60
TIB-EL-60-C1.5
TIB-EL-60-C3

Engaging
Engaging
Engaging

TIB-NL-60
TIB-NL-60-C1.5
TIB-NL-60-C3

Non-Engaging
Non-Engaging
Non-Engaging

CIA Abutments



CIA-EL-60
CIA-NL-60

Engaging
Non-Engaging

PASSIVE Abutment



PA-EL-60
PA-NL-60

Engaging
Non-Engaging

Software Selection

Main Selection
SI TIB TRI-NEX

Secondary Selection
TIB-EL-60 EN
TIB-EL-60-C1.5 EN
TIB-EL-60-C3 EN

TIB-NL-60 NE
TIB-NL-60-C1.5 NE
TIB-NL-60-C3 NE

Main Selection
SI CIA TRI-NEX

Secondary Selection
CIA-EL-60 EN
CIA-NL-60 NE

Main Selection
SI PASSIVE TRI-NEX

Secondary Selection
PA-EL-60 EN
PA-NL-60 NE

Retaining Screws

TS-L-20



Titanium

TS-L-20C



Coated

GS-L-20



Gold

BS-L-20



Brass

*(Blackened
- for laboratory
use only)

PA-L-20



Titanium

PA-L-20G



Gold

PA-L-20B*



Brass

Implants



CODE	LENGTHS
IA-LH-60-	8 / 10 / 11.5 / 13 / 16
TRI-MAX8	7 / 9 / 11
TRI-MAX9	7 / 9 / 11

TIB Abutment

TIB-EL-60
 TIB-EL-60-C1.5
 TIB-EL-60-C3

 TIB-NL-60
 TIB-NL-60-C1.5
 TIB-NL-60-C3



Engaging
 Engaging
 Engaging

 Non-Engaging
 Non-Engaging
 Non-Engaging

3rd Party Scanbody



Software Selection

NB RS 6.0L

Retaining Screws

TS-L-20



Titanium

TS-L-20C



Coated

GS-L-20



Gold

BS-L-20



Brass

*(Blackened
 - for laboratory
 use only)

Direct

Implants



CODE	LENGTHS
ITC3	06 / 08 / 10 / 12 / 14
ITT4	08 / 10 / 12 / 14
ITC4	06 / 08 / 10 / 12 / 14
ITC5	06 / 08 / 10 / 12 / 14
ITT5	08 / 10 / 12 / 14
ITST12d-4xxf	08 / 10 / 12 / 14
ITST12d-5xxf	08 / 10 / 12 / 14
MAXIT7-	7 / 9 / 11

Scanning Flag



Digital Analogues



Prosthetic Components

TIB Abutments



TIB-ITS
TIB-ITS-C1.5
TIB-ITS-C3
 Engaging
 Engaging
 Engaging
TIB-ITSNE
TIB-ITSNE-C1.5
TIB-ITSNE-C3
 Non-Engaging
 Non-Engaging
 Non-Engaging

Main Selection
SI TIB IT
Secondary Selection
TIB-ITS EN
TIB-ITS-C1.5 EN
TIB-ITS-C3 EN
TIB-ITSNE NE
TIB-ITSNE-C1.5 NE
TIB-ITSNE-C3 NE

CIA Abutments



CIA-ITS
CIA-ITS-NE
 Engaging
 Non-Engaging

Main Selection
SI CIA IT
Secondary Selection
CIA-ITS EN
CIA-ITS-NE NE

PASSIVE Abutment



ITS-PA
ITS-PA-NE
 Engaging
 Non-Engaging

Main Selection
SI PASSIVE IT
Secondary Selection
ITS-PA EN
ITS-PA-NE NE

Retaining Screws

TS-TIB-IT



TSIT2



Titanium

GSIT2



Gold

BSIT2*



Brass

TS-IT-PA



Titanium

BS-IT-PA*



Brass

* (Blackened for laboratory use only)

Implants



CODE	LENGTHS
ITC3	06 / 08 / 10 / 12 / 14
ITT4	08 / 10 / 12 / 14
ITC4	06 / 08 / 10 / 12 / 14
ITC5	06 / 08 / 10 / 12 / 14
ITT5	08 / 10 / 12 / 14
ITST12d-4xxf	08 / 10 / 12 / 14
ITST12d-5xxf	08 / 10 / 12 / 14
MAXIT7-	7 / 9 / 11

TIB Abutment

TIB-ITS
TIB-ITS-C1.5
TIB-ITS-C3
TIB-ITSNE
TIB-ITSNE-C1.5
TIB-ITSNE-C3



Engaging
 Engaging
 Engaging
 Non-Engaging
 Non-Engaging
 Non-Engaging

3rd Party Scanbody



Software Selection

NB RS 4.3L

Retaining Screws



Direct

Implants



CODE LENGTHS

ITC6-5	06 / 08 / 10 / 12 / 14
ITT6-5	08 / 10 / 12 / 14
ITT6	08 / 10 / 12 / 14
MAXIT®8-	7 / 9 / 11
MAXIT®9-	7 / 9 / 11

Scanning Flag



Digital Analogues



Prosthetic Components

TIB Abutments



TIB-IT6
TIB-IT6-C1.5
TIB-IT6-C3
TIB-IT6NE
TIB-IT6NE-C1.5
TIB-IT6NE-C3

Engaging
 Engaging
 Engaging
 Non-Engaging
 Non-Engaging
 Non-Engaging

CIA Abutments



CIA-ITS6
CIA-ITS6-NE

Engaging
 Non-Engaging

PASSIVE Abutment



ITS6-PA
ITS6-PA-NE

Engaging
 Non-Engaging

Software Selection

Main Selection
SI TIB IT

Secondary Selection
TIB-IT6 EN
TIB-IT6-C1.5 EN
TIB-IT6-C3 EN

TIB-IT6NE NE
TIB-IT6NE-C1.5 NE
TIB-IT6NE-C3 NE

Main Selection
SI CIA IT

Secondary Selection
CIA-ITS6 EN
CIA-ITS6-NE

Main Selection
SI PASSIVE IT

Secondary Selection
ITS6-PA EN
ITS6-PA-NE

Retaining Screws

TS-TIB-IT



TSIT2



Titanium

GSIT2



Gold

BSIT2*



Brass

TS-IT-PA



Titanium

BS-IT-PA*



Brass

* (Blackened for laboratory use only)

Implants

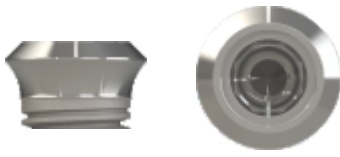

CODE	LENGTHS
ITC6-5	06 / 08 / 10 / 12 / 14
ITT6-5	08 / 10 / 12 / 14
ITT6	08 / 10 / 12 / 14
MAXIT®8-	7 / 9 / 11
MAXIT®9-	7 / 9 / 11

TIB Abutment

TIB-IT6
TIB-IT6-C1.5
TIB-IT6-C3
TIB-IT6NE
TIB-IT6NE-C1.5
TIB-IT6NE-C3



Engaging
 Engaging
 Engaging
 Non-Engaging
 Non-Engaging
 Non-Engaging

3rd Party Scanbody

































Software Selection

NB RS 6.0L

Retaining Screws

TS-TIB-IT













1.22mm	External Hex	DC				
I-HD-LH		I-HD-S	I-HHD-22S	I-WI-22S	Hexed	
						
Unigrip	External Hex	TRI-NEX				
I-UD-LH		I-UGI-S/M/L	I-HUG-S/M/L	I-WI-UG-S/M/L	Unigrip	
						
Quad	External Hex	Internal Hex				
I-QD-LH		I-QDI-S/M/L	I-HQD-S/M/L	I-WI-QS/M/L	Quad	
						
Blade	External Hex					
I-BD-LH		I-BD-S/M/L	I-HBDS/M/L	I-WI-BS/M/L	Slotted	
						
Torx	External Hex	IT				
I-SCS-LH		I-SCS-S/M/L	I-SCS-S/M/L	I-WI-SCS-S/M/L	Torx	
						
1.27mm		Internal Hex				
I-HD-27-LH		I-HD-27S/M/L	I-HHD-27S/M/L	I-WI-27S/M/L	Hexed	
						

POLISHING PROTECTOR CAPS



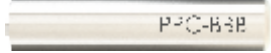

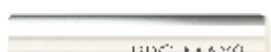

These items are used to protect the interface and edges of various components, castings, and abutments when polishing. They are attached to the relevant cast components, using the appropriate laboratory screw. Polishing then commences according to standard laboratory procedures.

- Short (**S**) Polishing Protector Caps are indicated when polishing multiple unit restorations.
- Long Polishing Protector Caps are indicated when polishing single unit restorations.
- All caps are made from a hardened stainless steel to ensure longer life.





EXTERNAL HEX IMPLANT RANGE

	CODE	S	Ø implant
	PPC-IBN		Ø3.25mm
	PPC-INPi		Ø3.25mm
	PPC-IB		Ø4.0mm
	PPC-BA		Ø5.0mm
	PPC-BBB		Ø6.0mm
	PPC-MAX9		Ø9.0mm









DC IMPLANT RANGE

	CODE	S	Ø implant
	PPC-DC3		Ø3.0mm
	PPC-DC4		Ø4.0mm
	PPC-DC5		Ø5.0mm





INTERNAL HEX (M-SERIES / PROVATA) IMPLANT RANGE

	CODE	S	Ø implant
	PPC-M		Standard restorative interface
	PPC-Z		Wide restorative interface



TRI-NEX IMPLANT RANGE

	CODE	S	Ø implant
	PPC-35		Ø3.5mm
	PPC-43		Ø4.3mm
	PPC-50		Ø5.0mm
	PPC-60		Ø6.0mm

IT IMPLANT RANGE

	CODE	S	Ø implant
	PPC-ITS		Ø4.8mm restorative interface
	PPC-ITS6		Ø6.5mm restorative interface

STANDARD ABUTMENTS

	PPC-AB-1	- replicates standard abutments with Ø4.50mm restorative interface
	PPC-AWB-1	- replicates wide standard abutments with Ø5.50mm restorative interface

CONICAL AND COMPACT CONICAL ABUTMENTS

	PPC-MC-1	- replicates compact conical abutments
	PPC-MCW-1	- replicates wide compact conical abutments

CONTRAINDICATIONS

Do not use in:

- patients who are allergic to or have hypersensitivity to Titanium, Titanium Alloy or Titanium
- patients who are medically unfit for implant procedures (e.g. uncontrolled diabetes and untreated infection in nearby bone)
- cases where an adequate number of implants cannot be placed to achieve full functional support for a prosthesis
- cases where there is insufficient blood supply to the implant site
- patients with insufficient mental health precluding patient co-operation
- patients who abuse drugs or alcohol
- cases where a pre-operative screening exposes possible risks to the healing of the bone or soft-tissue
- patients who by nature of their condition, occupation or activity will be unable to keep the implant site clean
- patients where site specific contraindications exist.

WARNINGS

All Southern Implants products are intended to be used by appropriately trained and licensed professionals. For the safe and effective use of Osseointegrated Fixtures, it is strongly suggested that specialised training be undertaken, including hands-on training to learn proper technique and radiographic evaluations. THESE INSTRUCTIONS ARE NOT INTENDED AS A SUBSTITUTE FOR ADEQUATE TRAINING. Responsibility for proper patient selection, adequate training, experience in the placement of implants, and providing appropriate information for informed consent, rests with the practitioner. Improper technique can result in damage to anatomical structures during placement, implant failure and/or loss of supporting bone. Southern Implants will not accept liability for damage caused by improper implant treatment.

Southern Implants osseointegrated fixtures have only been validated for use with the corresponding Southern Implants abutments and accessories. Although care has been taken to create interfaces that are equivalent to similar products on the market, Southern Implants cannot guarantee outcomes obtained using components from other manufacturers. Southern Implants will not accept liability for damage caused by improper selection of incompatible abutments and accessories.

Failure to recognize actual drill lengths relative to radiographic measurements can result in permanent injury to nerves or other vital structures.

Do not re-use Implants, Cover screws, Temporary Abutments and Abutments. These are single-use products. DO NOT re-sterilize or autoclave these components. Re-using these components may result in damage on the surface or critical dimensions. This may result in performance and compatibility issues. The removal of proteins from metal (such as Titanium) is extremely difficult and re-use can lead to secondary infections. Sterility is assured unless the container or seal is damaged or opened.

Electro-surgery should not be attempted around metal implants, as they are conductive.

One hundred percent implant success cannot be guaranteed. Non-observance of the indicated limitations of use and working steps may result in failure. Minimizing trauma to the host tissue increases the potential for successful osseointegration.

CAUTIONS

New and experienced Implant users should do training before using a new system or attempt to do a new treatment method.

Take special care when treating patients who have local or systemic factors that could affect the healing of the bone and soft tissue. (I.e. poor oral hygiene, uncontrolled diabetes, are on steroid therapy, smokers, infection in the nearby bone and patients who had oro-facial radiotherapy.)

Thorough screening of prospective implant candidates must be performed including:

A comprehensive medical and dental history.

Visual and radiological inspection to determine adequate bone dimensions, anatomical landmarks, occlusal conditions, periodontal status, and adequacy of bone.

Bruxism and unfavourable jaw relations must be taken into account.

Proper pre-operative planning with a good team approach between well trained surgeons, restorative dentists and lab technicians is essential for successful implant treatment.

Minimizing the trauma to the host tissue increases the potential for successful osseointegration.

Electro-surgery should not be attempted around metal implants, as they are conductive.

Re-use of single-use items may result in damage on the surface or to critical dimensions.

During procedure

Care must be taken that parts are not swallowed during any of the procedures, thus rubber-dam application is recommended when appropriate.

Care must be taken to apply the correct tightening torque of abutments and abutment screws.

Post-procedure

Regular patient follow-up, and proper oral hygiene must be achieved are essential for favourable long-term results.

GENERAL INFORMATION AND WARNINGS

PACKAGING

- 1) Components are packed in a peel pouch. Labeling information is located on the bottom half of the pouch inside the packet.
- 2) Non-sterile components used in the laboratory are supplied clean but not sterile. These are: laboratory analogs, passive abutments, cast waxing sleeves, casting precision tools and gold abutments with plastic sleeves.

CLEANING

- Refer to CAT-1039
- Final restoration should be cleaned and disinfected, as per restorative material manufacturer's instructions, before intra oral use.
- Used surgical trays including grommets must be cleaned with suitable disinfectants.
- Multiple-part instruments must be disassembled prior to cleaning and sterilization.
- Internal debris/residue on instruments must be removed with a soft brush.
- Instruments should be inspected, cleaned separately and discarded if damaged.
- Best results are achieved if instruments are cleaned by material type.
- Instruments and trays can be cleaned and disinfected in a dedicated instrument washer or alternatively by hand, followed by an ultrasonic bath with a detergent appropriate for surgical instruments.
- Instruments and trays must be rinsed and dried thoroughly.

STERILIZATION

- Refer to CAT-1039
- Pre-vacuum sterilization method: Steam sterilize the component at 132°C (270°F) at 180-220 kPa for 4 minutes, or at 135°C (275°F) at 180-220 kPa for 3 minutes. Dry for at least 20 minutes in the chamber. Only an appropriate regulatory authority approved sterilizer and wrap/pouch for steam sterilization must be used.
- It is the responsibility of the user to establish whether or not their sterilizer is appropriate regulatory authority approved to meet the recommended parameters.
- The product must be stored in a dry place in the original packaging at room temperature and not exposed to direct sunlight. Incorrect storage may influence device characteristics.

STORAGE

- Maintain original packaging integrity in storage.
- Devices should be stored at room temperature and must not be exposed to direct sunlight.
- Incorrect storage may influence device characteristics.
- Packaging, after re-sterilization, should be dry before storage to avoid corrosion and degradation of cutting edges.

DISPOSAL

Disposal of the device and its packaging shall follow local regulations and environmental requirements, taking different contamination levels into account.

MAGNETIC RESONANCE (MR) SAFETY INFORMATION

This device has not been evaluated for safety and compatibility in the MR environment. It has not been tested for heating, migration, or image artefact in the MR environment. The safety of this device in the MR environment is unknown. Scanning a patient who has this device may result in patient injury.

CAUTION: (USA ONLY)

United States Federal Law restricts this device to sale to, or on the order of, a licensed dentist or physician.

DISCLAIMER OF LIABILITY

This product is part of the Southern Implants' product range and should only be used with the associated original products, according to the recommendations as in the individual product catalogues. The user of this product has to study the development of the Southern Implants' product range and take full responsibility for the correct indications and use of this product. Southern Implants does not assume liability for damage due to incorrect use. Please note that some Southern Implants' products may not be cleared or released for sale in all markets.

For more information, please visit your
Southern Implants Representative or
visit southernimplants.com

EXPLANATION OF SYMBOLS

The following symbols are used on our packaging labels and they indicate the following:

- 1  **Manufacturer**
- 2  **Colour code indicating platform diameter**
- 3  **Implant image**
- 4  **Implant details and size**
- 5  **Sterilization using Irradiation**
-  **Do not Re-sterilize**
-  **Consult instruction for use**
-  **Do not reuse**
-  **CE mark and notified body number**
-  **Expiry date**
-  **Sterile unless package is opened or damaged**

- 6 **2D Bar coding**
Contains the GTIN, Expiry Date and LOT Number
- 7 **Patient sticker for documentation purposes**
(to be used by health care provider on patient file)
- 8  **Prescription device**

CAUTION: FEDERAL LAW RESTRICTS THE DEVICE TO SALE BY, OR ON THE ORDER OF, A LICENCED HEALTH CARE PROVIDER.

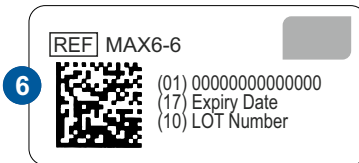
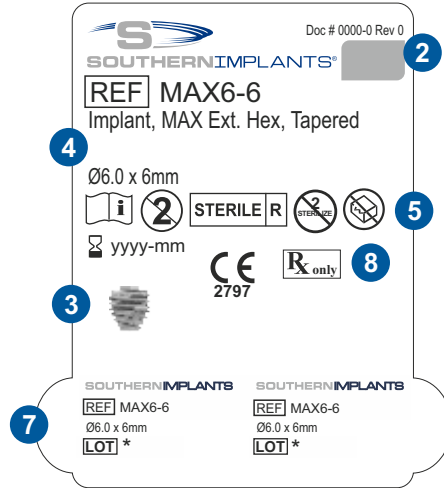

For more information, please contact your
Southern Implants Representative or visit southernimplants.com



South Africa - Headquarters 1 Albert Road, Irene, RSA
T: +27-12-667-1046 | **E:** info@southernimplants.com

Subsidiaries

Australia
Southern Implants Australia
T: +61-2-8076-9337
E: info@southernimplants.com.au

United Kingdom
Southern Implants UK
T: +44-20-8899-6845 / 6 / 7
E: info@southernimplants.co.uk

USA and Canada
Southern Implants North America Inc.
T: +1-561-472-0990
E: customercare@southernimplants.com

Southern Implants Products are distributed world-wide, please visit southernimplants.com for a list of Distributors.

©2019 Southern Implants (Pty) Ltd. All rights reserved. Co-Axis, Southern Implants, and Subcrestal Angle Correction are registered trademarks and Body-Shift, INVERTA and PROVATA are trademarks of Southern Implants (Pty) Ltd. Not all implants are available in all markets.

CAT-2063-01 (C1070)